

OBJECTIVES:

Providing an overview of Power Plants and detailing the role of Mechanical Engineers in their operation and maintenance.

UNIT I COAL BASED THERMAL POWER PLANTS 10

Rankine cycle - improvisations, Layout of modern coal power plant, Super Critical Boilers, FBC Boilers, Turbines, Condensers, Steam & Heat rate, Subsystems of thermal power plants – Fuel and ash handling, Draught system, Feed water treatment. Binary Cycles and Cogeneration systems.

UNIT II DIESEL, GAS TURBINE AND COMBINED CYCLE POWER PLANTS 10

Otto, Diesel, Dual & Brayton Cycle - Analysis & Optimisation. Components of Diesel and Gas Turbine power plants. Combined Cycle Power Plants. Integrated Gasifier based Combined Cycle systems.

UNIT III NUCLEAR POWER PLANTS 7

Basics of Nuclear Engineering, Layout and subsystems of Nuclear Power Plants, Working of Nuclear Reactors : *Boiling Water Reactor* (BWR), *Pressurized Water Reactor* (PWR), CANada Deuterium-Uranium reactor (CANDU), Breeder, Gas Cooled and Liquid Metal Cooled Reactors. Safety measures for Nuclear Power plants.

UNIT IV POWER FROM RENEWABLE ENERGY 10

Hydro Electric Power Plants – Classification, Typical Layout and associated components including Turbines. Principle, Construction and working of Wind, Tidal, *Solar Photo Voltaic* (SPV), Solar Thermal, Geo Thermal, Biogas and Fuel Cell power systems.

UNIT V ENERGY, ECONOMIC AND ENVIRONMENTAL ISSUES OF POWER PLANTS 8

Power tariff types, Load distribution parameters, load curve, Comparison of site selection criteria, relative merits & demerits, Capital & Operating Cost of different power plants. Pollution control technologies including Waste Disposal Options for Coal and Nuclear Power Plants.

57

TOTAL : 45 PERIODS

OUTCOMES:

Upon completion of this course, the Students can able to understand different types of power plant, and its functions and their flow lines and issues related to them.

Analyse and solve energy and economic related issues in power sectors.

TEXT BOOK:

1. P.K. Nag, Power Plant Engineering, Tata McGraw – Hill Publishing Company Ltd., Third Edition, 2008.

REFERENCES:

1. M.M. El-Wakil, Power Plant Technology, Tata McGraw – Hill Publishing Company Ltd., 2010.

2. Black & Veatch, Springer, Power Plant Engineering, 1996.

3. Thomas C. Elliott, Kao Chen and Robert C. Swanekamp, Standard Handbook of Power Plant Engineering, Second Edition, McGraw – Hill, 1998.

CONTENTS

S.NO	TOPIC	PAGE NO.
UNIT I COAL BASED THERMAL POWER PLANTS (2 MARKS)		4
1.1	Working of thermal power plant	9
1.2	Type of Basic Boilers thermodynamic cycles	13
1.3	Process of the Rankine Cycle	14
1.4	Atmospheric Fluidized Bed Combustion	23
1.5	Fuel Handling System	46
1.6	Draught System	44
1.7	Compare Forced and Induced Draught	52
1.8	Super heater	55
1.9	Governing Mechanism	60
UNIT II DIESEL,GAS TUBINE AND COMBINED CYCLE POWER PLANTS		
2.1	Water Tube Boilers	69
2.2	Steam and Water drum	72
2.3	Mud box	77
2.4	Water tube boiler over fire tube boilers	79
2.5	Boiler Accessories	80
2.6	pumped storage plants	82
2.7	Draft tubes	85
UNIT III NECLEAR POWER PLANTS		87
3.1	Nuclear radiation	89
3.2	Chain reaction	90
3.3	types of Reactors	92
3.4	Pressurized Water Reactor (PWR)	93
3.5	Main components of nuclear power plants	95
3.6	Liquid Metal Cooled Reactors	97
UNIT IV POWER FROM RENEWABLE ENRGY		98
4.1	Hydro power plants	100
4.2	Components of power plants	102
4.3	Tidal ,solar (SPV)	103
4.4	Geo Thermal	104
4.5	Boi-Gas	108
4.6	Fuel Cell Power system	110
UNIT V ENERGY,ECONAMIC AND ENVIRONMENTAL ISSUES OF PLANTS		112
5.1	Tariff types load distributions	115
5.2	Operating cost of power plants	120
5.3	Selection of sites	121
5.4	Relative merits	122
5.5	Waste disposal	124
	University Questions	124

COAL BASED THERMAL POWER PLANTS

1. What are the types of power plants?

1. Thermal Power Plant
2. Diesel Power Plant
3. Nuclear Power Plant
4. Hydel Power Plant
5. Steam Power Plant
6. Gas Power Plant
7. Wind Power Plant
8. Geo Thermal
9. Bio – Gas
10. M.H.D. Power Plant

2. What are the flow circuits of a thermal Power Plant?

1. Coal and ash circuits.
2. Air and Gas
3. Feed water and steam
4. Cooling and water circuits

3. List the different types of components (or) systems used in steam (or) thermal power plant?

1. Coal handling system.
2. Ash handling system.
3. Boiler
4. Prime mover
5. Draught system.
 - a. Induced Draught
 - b. Forced Draught

4. What are the merits of thermal power plants?

Merits (Advantages) of Thermal Power Plant:

1. The unit capacity of thermal power plant is more. The cost of unit decreases with the increase in unit capacity
2. Life of the plant is more (25-30 years) as compared to diesel plant (2-5 years)

3. Repair and maintenance cost is low when compared with diesel plant
4. Initial cost of the plant is less than nuclear plants
5. Suitable for varying load conditions.

5. What are the Demerits of thermal power plants?

Demerits of thermal Power Plants:

1. Thermal plant are less efficient than diesel plants
2. Starting up the plant and brining into service takes more time
3. Cooling water required is more
4. Space required is more.

6. What are the various steps involved in coal handling system?

1. coal delivery
2. Unloading,
3. Preparation
4. Transfer
5. Outdoor storage
6. Covered storage
7. In-Plant handling
8. Weighing and measuring
9. Feeding the coal into furnace

7. After coal preparation, How the coal transfer?

1. Belt conveyors
2. Screw conveyors
3. Bucket elevation
4. Grab bucket elevators
5. Skip hoists
6. Flight conveyor.

8. Write the advantages of belt conveyor?

1. Its operation is smooth and clean,
2. It requires less power as compared to other types of systems.
3. Large quantities of coal can be discharged quickly and continuously,
4. Material can be transported on moderate inclines.

9. What are the systems used for pulverized coal firing?

1. Unit system or Direct system
2. Bin or Central system

10. Write the classification of Mechanical Stokers?

1. Travelling grate stoker
2. Chain grate stoker
3. Spreader stoker
4. Vibrating grate Stoker
5. Underfeed stoker.

11. What are the three major factor consider for ash disposal system?

1. Plant site
2. Fuel source
3. Environmental regulation

12. Write the classification of Ash handling system?

1. Hydraulic system,
2. Pneumatic system
3. Mechanical system

13. What are the Ash discharge equipments?

1. Rail road cars
2. Motors truck
3. Barge

14. Define Draught.

Draught is defined as the difference between absolute gas pressure at any point in a gas flow passage and the ambient (same elevation) atmospheric pressure.

15. What are the purpose of Draught.

- (i) To supply required amount of air to the furnace for the combustion of fuel. The amount of fuel can be burnt per square foot of grate depends upon the quantity of air circulated through fuel bed.
- (ii) To remove the gaseous products of combustion.

16. Write the classification of Draught?

The following flow chart gives the classification of draughts

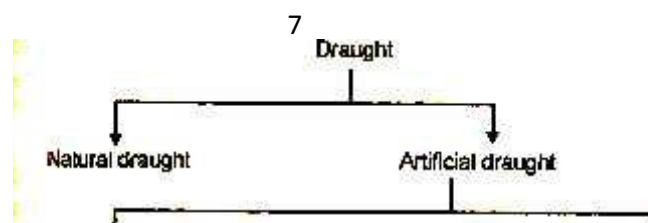

17. Define artificial draught?

If the draught is produced by steam jet or fan it is known as artificial draught.

18. Define Induced draught?

The flue is drawn (sucked) through the system by a fan or steam jet.

19. Define Forced draught?

The air is forced into the system by a blower or steam jet.

20. Write the merits of Natural Draught?

1. No external power is required for creating the draught
2. Air pollution is prevented since the flue gases are discharged at a higher level
3. Maintenance cost is practically nil since there are no mechanical parts
4. Its has longer life,
5. Capital cost is less than that of an artificial draught.

21. Write the De-merits of Natural Draught?

1. Maximum pressure available for producing draught by the chimney is less,
2. Flue gases have to be discharged at higher temperature since draught increases with the increase in temperature of flue gases.
3. Heat cannot be extracted from the fluid gases for economizer, superheater, air pre-heater, etc. Since the effective draught will be reduced if the temperature of the flue gases is decreased.

22. Write the merits of steam Jet draught?

1. This system is very simple and cheap in cost,

2. Low grade fuel can be used
3. Space required is less

23. Write the De-merits at steam jet draught?

1. It can be operated only when the steam is raised
2. The draught produced is very low

24. Define Condenser?

A condenser is a device in which the steam is condensed by cooling it with water. The condensed steam is known as condensate.

25. Write the essential elements of a steam condensing plant?

1. A closed vessel in which the steam is condensed.
2. A pump to deliver condensed steam to the hot well from the condenser.
3. A dry air-pump to remove air and other non-condensable gases,
4. A feed pump to deliver water to the boiler from hot well.

26. What are the sub division of jet condensers?

1. Low level counter flow jet condenser
2. High level (or) Barometric jet condenser
3. Ejector condenser.

27. Write the surface condenser?

1. Down flow condenser
2. Central flow condenser
3. Evaporative condenser

28. Write the advantages of surface condenser?

1. The condensate can be used as boiler feed water
2. Cooling water of even poor quality can be used because the cooling water does not come in direct contact with steam
3. High vacuum (about 73.5 cm of Hg) can be obtained in the surface condenser. This increases the thermal efficiency of the plant.

29. Write the disadvantages of surface condenser?

1. The capital cost is more,
2. The maintenance cost and running cost of this condenser is high,
3. It is bulky and requires more space.

30. Name any two heat saving devices used in a thermal power plant?

1. Air pre heater
2. Economizer.

1.1 Working of thermal power plant

Layout of steam power plant:

Introduction:

Steam is an important medium for producing mechanical energy. Steam is used to drive steam engines and steam turbines. Steam has the following advantages.

1. Steam can be raised quickly from water which is available in plenty.
2. It does not react much with materials of the equipment used in power plants.
3. It is stable at temperatures required in the plant.

Equipment of a Steam Power Plant:

A steam power plant must have the following equipment.

1. A furnace for burning the fuel.
2. A steam generator or boiler for steam generation.
3. A power unit like an engine or turbine to convert heat energy into mechanical energy.
4. A generator to convert mechanical energy into electrical energy.
5. Piping system to carry steam and water.

Figure: shows a schematic layout of a steam power plant. The working of a steam power plant can be explained in four circuits.

1. Fuel (coal) and ash circuit
2. Air and flue gas circuit
3. Feed water and steam flow circuit
4. Cooling water flow circuit

1. Coal and Ash circuit:

This includes coal delivery, preparation, coal handling, boiler furnace, ash handling and ash storage. The coal from coal mines is delivered by ships, rail or by trucks to the power station. This coal is sized by crushers, breakers etc. The sized coal is then stored in coal storage (stock yard). From the stock yard, the coal is transferred to the boiler furnace by means of conveyors, elevators etc.

The coal is burnt in the boiler furnace and ash is formed by burning of coal, Ash coming out of the furnace will be too hot, dusty and accompanied by some poisonous gases. The ash is transferred to ash storage. Usually, the ash is quenched to reduced temperature corrosion and dust content.

There are different methods employed for the disposal of ash. They are hydraulic system, water jetting, ash sluice ways, pneumatic system etc. In large power plants hydraulic system is used. In this system, ash falls from furnace grate into high velocity water stream. It is then carried to the slumps. A line diagram of coal and ash circuit is shown separately in figure.

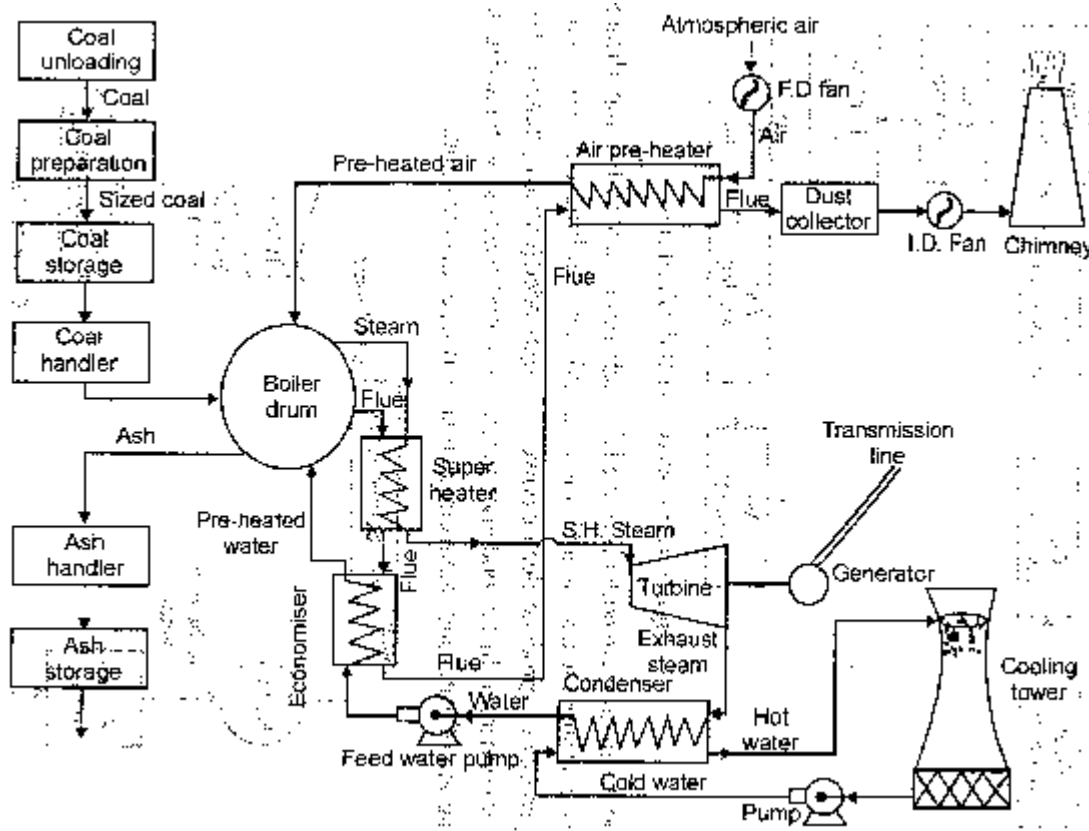

Figure: Layout of a steam power plant.

2. Water and Steam circuit

It consists of feed pump, economizer, boiler drum, super heater, turbine condenser etc.

Feed water is pumped to the economizer from the hot well. This water is preheated by the flue gases in the economizer. This preheated water is then supplied to the boiler drum. Heat is transferred to the water by the burning of coal. Due to this, water is converted into steam.

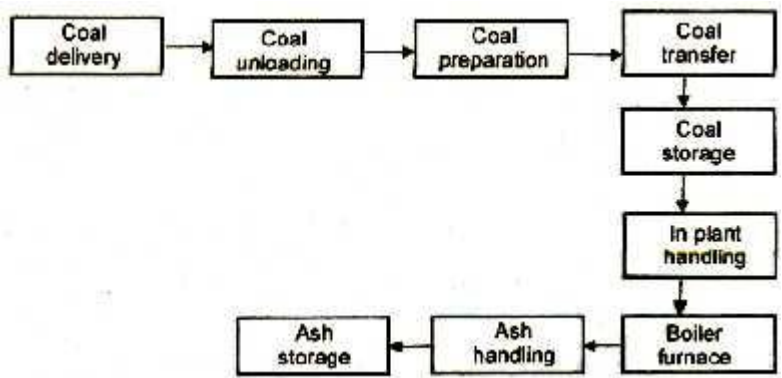

Figure: Fuel (coal) and ash circuit

The steam raised in boiler is passed through a super heater. It is superheated by the flue gases. The superheated steam is then expanded in a turbine to do work. The turbine drives a generator to produce electric power. The expanded (exhaust) steam is then passed through the condenser. In the condenser, the steam is condensed into water and recirculated. A line diagram of water and steam circuit is shown separately in figure.

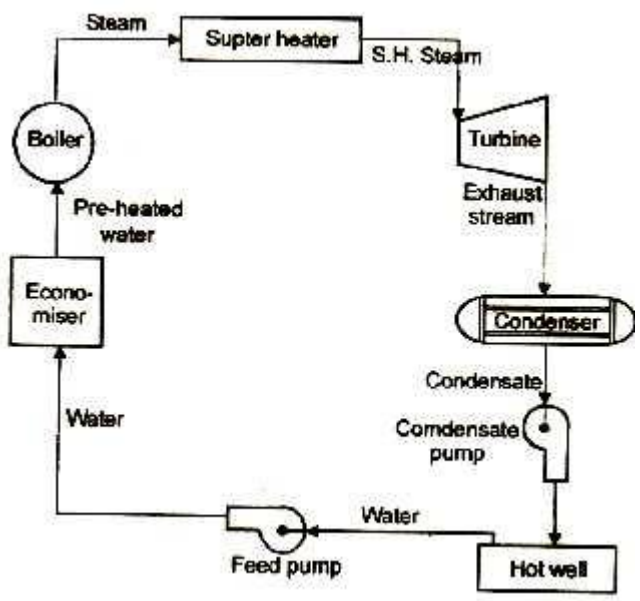

Figure: Water and Steam circuit

3. Air and Flue gas circuit

It consists of forced draught fan, air pre heater, boiler furnace, super heater, economizer, dust collector, induced draught fan, chimney etc. Air is taken from the atmosphere by the action

of a forced draught fan. It is passed through an air pre-heater. The air is pre-heated by the flue gases in the pre-heater. This pre-heated air is supplied to the furnace to aid the combustion of fuel. Due to combustion of fuel, hot gases (flue gases) are formed.

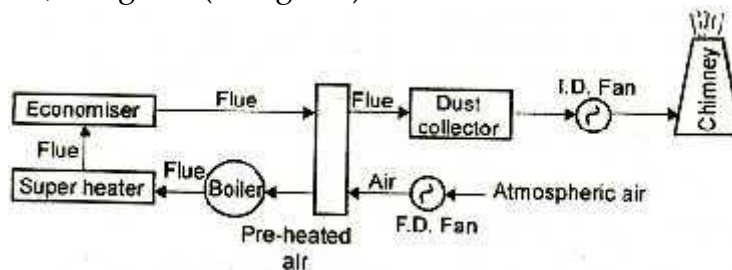

Figure: Air and flue gas circuit

The flue gases from the furnace pass over boiler tubes and super heater tubes. (In boiler, wet steam is generated and in super heater the wet steam is superheated by the flue gases.) Then the flue gases pass through economizer to heat the feed water. After that, it passes through the air pre-heater to pre-heat the incoming air. It is then passed through a dust catching device (dust collector). Finally, it is exhausted to the atmosphere through chimney. A line diagram of air and flue gas circuit is shown separately in figure.

4. Cooling water circuit:

The circuit includes a pump, condenser, cooling tower etc. the exhaust steam from the turbine is condensed in condenser. In the condenser, cold water is circulated to condense the steam into water. The steam is condensed by losing its latent heat to the circulating cold water.

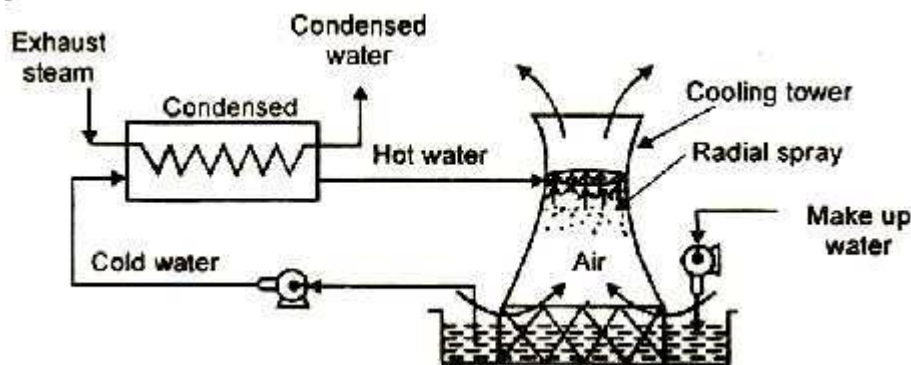

Figure: Cooling water current.

Thus the circulating water is heated. This hot water is then taken to a cooling tower, In cooling tower, the water is sprayed in the form of droplets through nozzles. The atmospheric air enters the cooling tower from the openings provided at the bottom of the tower. This air removes heat from water. Cooled water is collected in a pond (known as cooling pond). This cold water is again circulated through the pump, condenser and cooling tower. Thus the cycle is repeated again and again. Some amount of water may be lost during the circulation due to vaporization

etc. Hence, make up water is added to the pond by means of a pump. This water is obtained from a river or lake. A line diagram of cooling water circuit is shown in figure separately.

Merits (Advantages) of a Thermal Power Plant

1. The unit capacity of a thermal power plant is more. The cost of unit decreases with the increase in unit capacity.
2. Life of the plant is more (25-30 years) as compared to diesel plant (2-5 years).
3. Repair and maintenance cost is low when compared with diesel plant.
4. Initial cost of the plant is less than nuclear plants.
5. Suitable for varying load conditions.
6. No harmful radioactive wastes are produced as in the case of nuclear plant.
7. Unskilled operators can operate the plant.
8. The power generation does not depend on water storage.
9. There are no transmission losses since they are located near load centres.

Demerits of thermal power plants

1. Thermal plant are less efficient than diesel plants
2. Starting up the plant and bringing into service takes more time.
3. Cooling water required is more.
4. Space required is more
5. Storage required for the fuel is more
6. Ash handling is a big problem.
7. Not economical in areas which are remote from coal fields
8. Fuel transportation, handling and storage charges are more
9. Number of persons for operating the plant is more than that of nuclear plants. This increases operation cost.
10. For large units, the capital cost is more. Initial expenditure on structural materials, piping, storage mechanisms is more.

1.2 Type of Basic Boilers thermodynamic cycles process of the Rankine cycle

BOILER CYCLES

In general, two important area of application for thermodynamics are:

1. Power generation
2. Refrefrigeration

Both are accomplished by systems that operate in thermodynamic cycles such as:

- a. Power cycles: Systems used to produce net power output and are often called engines.
- b. Refrigeration cycles: Systems used to produce refrefrigeration effects are called refrefrigerators

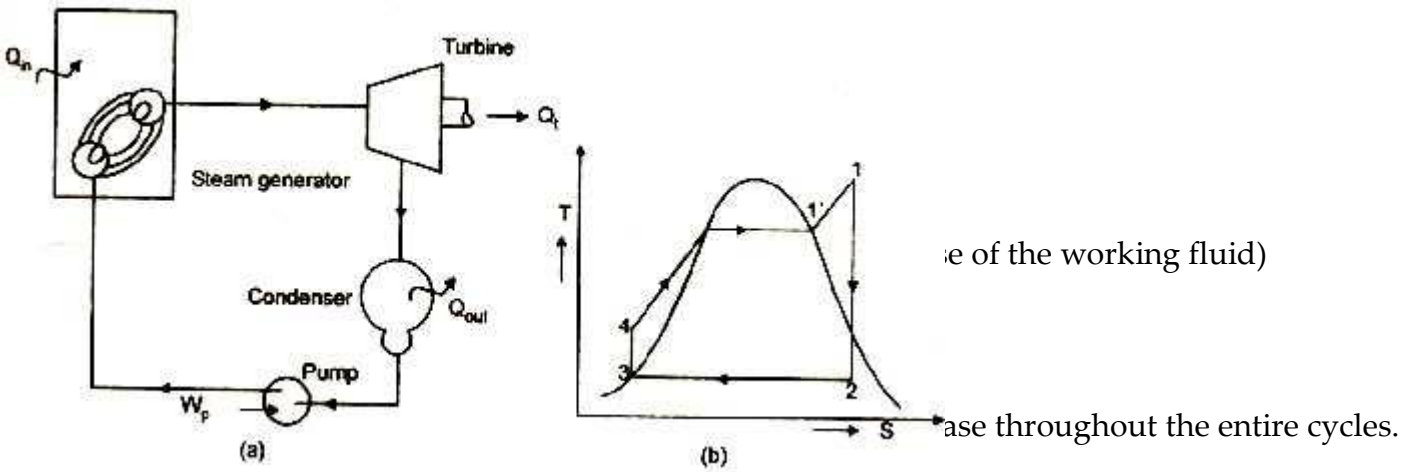

2. Vapour power cycles

In this case, the working fluid exists in the vapour phase during one part of the cycle and in the liquid phase during another part.

Vapour power cycles can be categorized as

- Carnot cycle
- Rankine cycle
- Reheat cycle
- Regenerative cycle
- Binary vapour cycle

Steam cycles (Ranking cycle)

The **Rankine cycle** is a thermodynamic cycle. Like other thermodynamic cycle, the maximum efficiency of the Rankine cycle is given by calculating the maximum efficiency of the Carnot cycle.

1.3 Process of the Rankine Cycle

Figure: Schematic representation and T-S diagram of Rankine cycle.

There are four processes in the Rankine cycle, each changing the state of the working fluid. These states are identified by number in the diagram above.

Process 3-4:

First, the working fluid (water) is enter the pump at state 3 at saturated liquid and it is pumped (ideally isentropically) from low pressure to high (operating) pressure of boiler by a pump to the state 4. During this isentropic compression water temperature is slightly increased. Pumping requires a power input (for example, mechanical or electrical). The conservation of energy relation for pump is given as

$$W_{\text{pump}} = m (h_4 - h_3)$$

Process 4-1:

The high pressure compressed liquid enters a boiler at state 4 where it is heated at constant pressure by an external heat source to become a saturated vapour at state 4' which in turn superheated to state 1 through super heater. Common heat source for power plant systems are coal (or other chemical energy), natural gas, or nuclear power. The conservation of energy relation for boiler is given as

$$Q_{\text{in}} = m (h_1 - h_4)$$

Process 1 – 2:

The superheated vapour enter the turbine at state 1 and expands through a turbine to generate power output. Ideally, this expansion is isentropic. This decreases the temperature and

pressure of the vapour at state 2. The conservation of energy relation for turbine is given as

$$W_{\text{turbine}} = m (h_1 - h_2)$$

Process 2 – 3:

The vapour then enters a condenser at state 2. At this state, steam is a saturated liquid-vapour mixture where it is cooled to become a saturated liquid at state 3. This liquid then re-enters the pump and the cycle is repeated. The conservation of energy relation for condenser is given as

$$Q_{\text{out}} = m (h_2 - h_3)$$

The exposed Rankine cycle can also prevent vapour overheating, which reduces the amount of liquid condensed after the expansion in the turbine.

Description

Rankine cycles describe the operation of steam heat engines commonly found in power generation plants. In such vapour power plants, power is generated by alternatively vaporizing

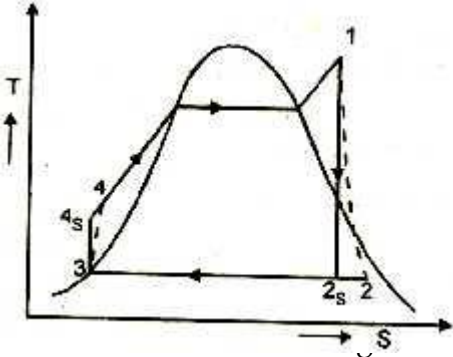

ng fluid (in many cases water, although refrigerants such as ammonia

in a Rankine cycle follows a closed loop and is re-used constantly. Water vapour seen billowing from power plants is evaporating cooling water, not working fluid. (NB: steam is invisible until it comes in contact with cool, saturated air, at which point it condenses and forms the white billowy clouds seen leaving cooling towers).

Variables

Q_{in} - heat input rate (energy per unit time)

m = mass flow rate (mass per unit time)

W - Mechanical power used by or provided to the system (energy per unit time)

η - thermodynamic efficiency of the process (power used for turbine per heat input, unit less).

The thermodynamic efficiency of the cycle as the ratio of net power output to heat input.

$$W_{net} = (W_{turbine} - W_{pump}) \text{ or } (Q_{in} - Q_{out})$$

$$\eta = W_{net} / Q_{in}$$

1.4 Real Rankine Cycle variation of Basic Rankine Cycle

Real Ranking Cycle (Non-ideal)

Figure:

In a real Rankine cycle, the compression by the pump and the expansion in the turbine are not isentropic. In other words, these processes are non-reversible and entropy is increased during the two process (indicated in the figure). This somewhat increases the power required by the pump and decreases the power generated by the turbine. It also makes calculations more involved and difficult.

Variation of the Basic Rankine Cycle:

Two main variations of the basic Rankine cycle to improve the efficiency of the steam cycles

are done by incorporating Reheater and Regenerator in the ideal ranking cycle.

Rankine cycle with reheat

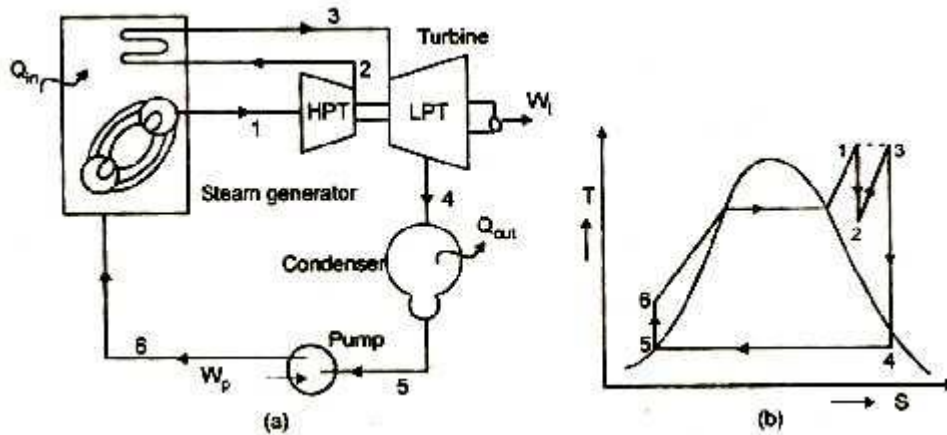
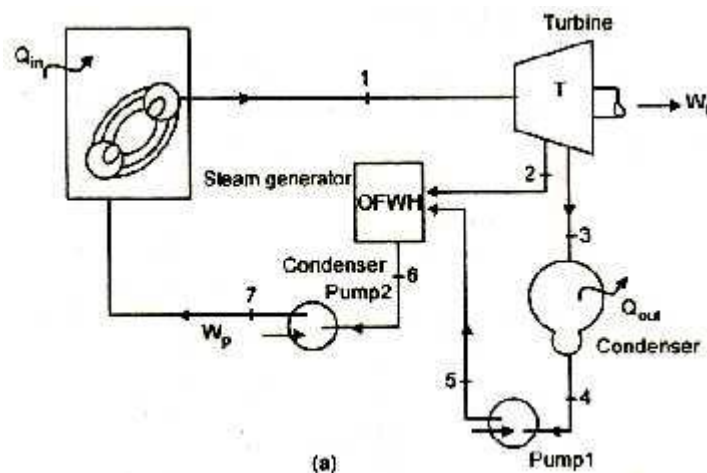

Figure: Schematic diagram and T-S diagram of Rankine cycle with reheat.

In this variation, two turbines work in series. The first accepts vapour from the boiler at high pressure. After the vapour has passed through the first turbine, it re-enters the boiler and is reheated before passing through a second, lower pressure turbine. Among other advantages, this prevents the vapour from condensing during its expansion which can seriously damage the turbine blades.

4. Explain a) Regenerative Ranking Cycle b) Binary Vapour Cycle?

The regenerative Ranking cycle is so named because after emerging from the condenser (possibly as a sub cooled liquid) the working fluid heated by steam tapped from the hot portion of the cycle and fed in to Open Feed Water Heater(OFWH). This increases the average temperature of heat addition which in turn increases the thermodynamics efficiency of the cycle.



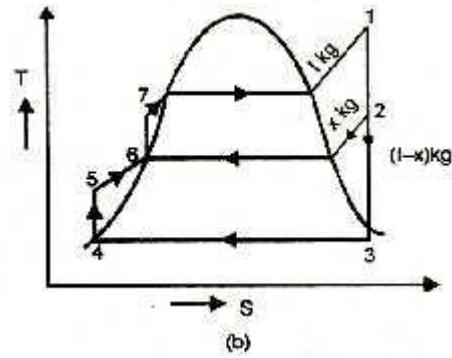

Figure

Binary Vapour Cycle

Generally water is used a working fluid in vapour power cycle as it is found to be better than any other fluid, but it is far from being the ideal one. The binary cycle is an attempt to overcome some of the shortcomings of water and to approach the ideal working fluid by using two fluids. The most important desirable characteristics of the working fluid suitable for vapour cycles are:

- a. A high critical temperature and a safe maximum pressure.
- b. Low- triple point temperature
- c. Condenser pressure is not too low.
- d. high enthalpy of vaporization
- e. High thermal conductivity
- f. It must be readily available, inexpensive, inert and non-toxic.

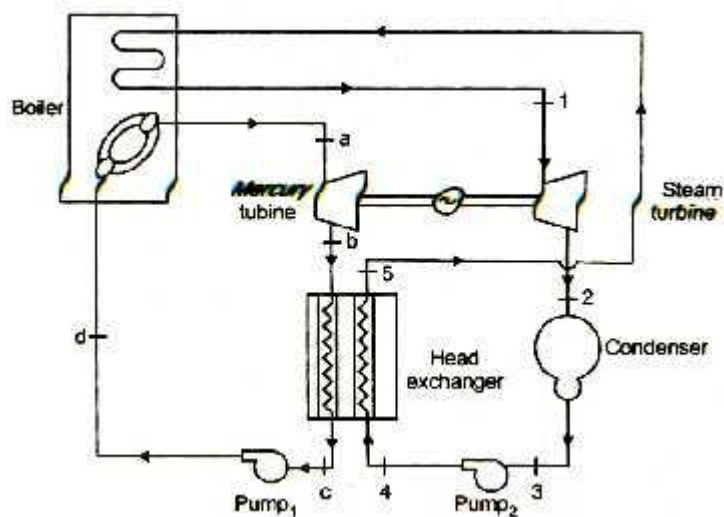

Figure: Mercury-steam binary vapour cycle

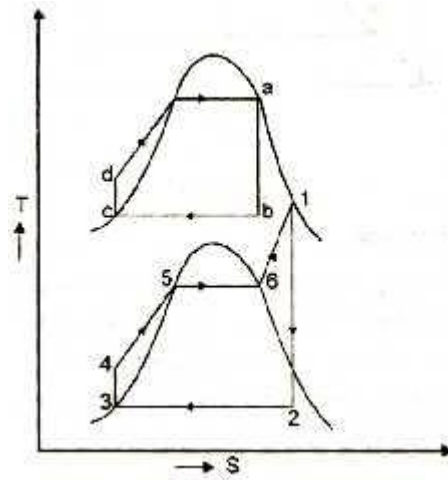

Figure: T-S diagram for Hg-steam binary vapour cycle.

Therefore it can be concluded that no single working fluids may have desirable requirements of working fluid. Different working fluids may have different attractive feature in them, but not all. In such cases two vapour cycles operating on two different working fluids are put together, one is high temperature region and the other in low temperature region and the arrangement is called binary vapour cycle.

The layout of mercury-steam binary vapour cycle is shown in figure. Along with the depiction of T-S diagram figure. Since mercury having high critical temperature (898°C) and low critical pressure (180 bar) which makes a suitable working fluid will act as high temperature cycle (toppling cycle) and steam cycle will act as low temperature cycle.

Here mercury vapour are generated in mercury boiler and sent for expansion in mercury turbine and expanded fluid leaves turbine to condenser. In condenser, the water is used for extracting heat from the mercury so as to condensate it. The amount water entering mercury condenser. The mercury condenser also act as steam boiler for super heating of heat liberated during condensation of mercury is too large to evaporate the water entering of seam an auxiliary boiler may be employed or superheating may be realized in the mercury boiler itself. From the cycle,

The net work obtained, $W_{net} = \sum W_{Hg} + W_{H_2O} - W_{pump}$

Since pump works are very small, it may be neglected.

Work from Mercury Turbine, $W_{Hg} = m_g (h_a - h_b)$

Work from Steam Turbine, $W_{steam} = m_{steam} (h_1 - h_2)$

Pump work, $W_{pump} = m_{Hg} (h_d - h_c) + m_{steam} (h_4 - h_3)$

Heat supplied to the cycle, $Q_{in} = m_{Hg} (h_a - h_d) + m_{steam} [(h_1 - h_6) + (h_5 - h_4)]$

Heat rejected, $Q_{out} = m_{steam} (h_2 - h_3)$

Efficiency of binary vapour cycle, $\eta_{bin\ vap} =$

$$= \frac{W_{net}}{Q_{in}}$$

Net work done

$$\text{Head Supplied} = \frac{W_{Hg} + W_{H_2O} - \sum W_{pump}}{Q_m}$$

$$\eta_{bip} = \frac{m_{Hg}(h_a - h_d) + m_{steam}[(h_1 - h_6) + (h_5 - h_4)]}{m_{Hg}(h_a - h_b) + m_{steam}(h_1 - h_2)}$$

v
a
p

=

$$m_{Hg}(h_a - h_b) + m_{steam}(h_1 - h_2)$$

1.5 Types of pulverised coal firing system

- (i) Unit system (or) Direct System
- (ii) Bin (or) Central system
- (iii) Semi direct firing system.

Pulverised Coal Firing System:

Pulverised coal firing is done by two systems:

- i) Unit system or Direct System.
- ii) Bin or Central system

Unit System:

In this system, the raw coal from the coal bunker drops on to the feeder.

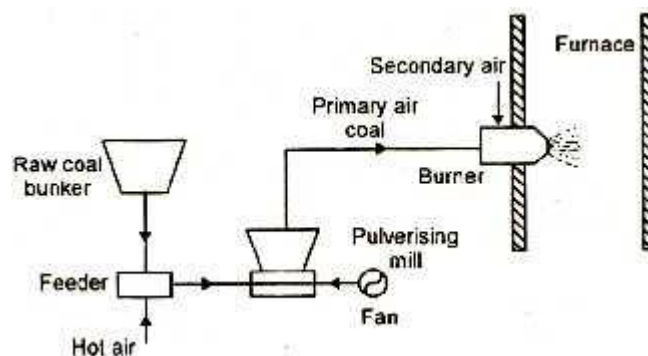

Figure: Unit System

Hot air is passed through coal in the factor to dry the coal. The coal is then transferred to the pulverising mill where it is pulverised. Primary air is supplied to the mill, by the fan. The mixture of pulverised coal and primary air then flows to burner where secondary air is added. The unit system is so called from the fact that each burner or a burner group and pulverizer

constitute a unit.

Advantages:

1. The system is simple and cheaper than the central system
2. There is direct control of combustion from the pulverising mill.
3. Coal transportation system is simple.

Central or Bin System

It is shown in figure. Crushed coal from the raw coal bunker is fed by gravity to a dryer where hot air is passed through the coal to dry it. The dryer may use waste flue gasses, preheated air or bleeder steam as drying agent. The dry coal is then transferred to the pulverising mill. The pulverised coal obtained is transferred to the pulverised coal bunker (bin). The transporting air is separated from the coal in the cyclone separator. The primary air is mixed with the coal at the feeder and the mixture is supplied to the burner.

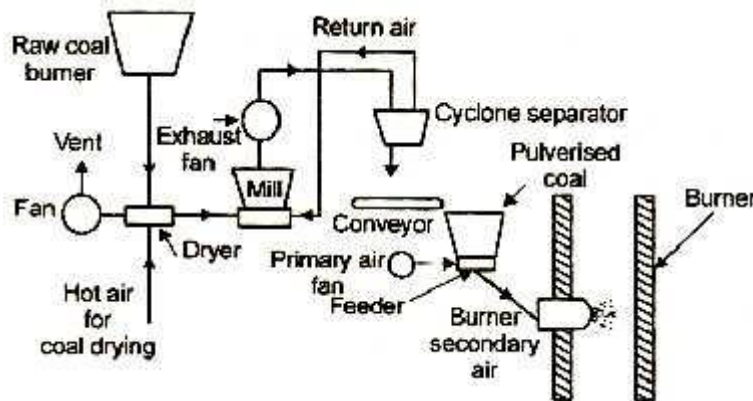

Figure: Central or Bin system

Advantages

1. The pulverising mill grinds the coal at a steady rate irrespective of boiler feed.
2. There is always some coal in reserve. Thus any occasional breakdown in the coal supply will not affect the coal feed to the burner.
3. For a given boiler capacity pulverising mill of small capacity will be required as compared to unit system.

Disadvantages

1. The initial cost of the system is high
2. Coal transport system is quite complicated
3. The system requires more space.

Semidirect Firing System:

A cyclone separator between the pulverizer and furnace separates the conveying medium from the coal. The hot primary air separated in the cyclone is used by the exhaustor or primary air

fan to push the coal particles, falling by gravity from the cyclone, through the burners into the furnace.

6. Draw and Explain the working principle of

- (a) Fluidized Bed Combustion**
- (b) Atmospheric bubbling bed combustor**
- (c) Circulating bed combustor**

And write the advantages of fluidized bed combustion:

Principles of Fluidized Bed Combustion Operation:

A fluidized bed is composed of fuel (coal, coke, biomass, etc.) and bed material (ash, sand, and/or sorbent) contained within an atmospheric or pressurized vessel. The bed becomes

fluidized when air or other gas flows upward at a velocity sufficient to expand the bed. The process is illustrated in figure. At low fluidizing velocities (0.9 to 3 m/s). relatively high solids densities are maintained in the bed and only a small fraction of the solids are entrained from the bed. A fluidized bed that is operated in this velocity range is referred to as a bubbling fluidized bed (BFB). A schematic of a typical BFB combustor is illustrated in figure.

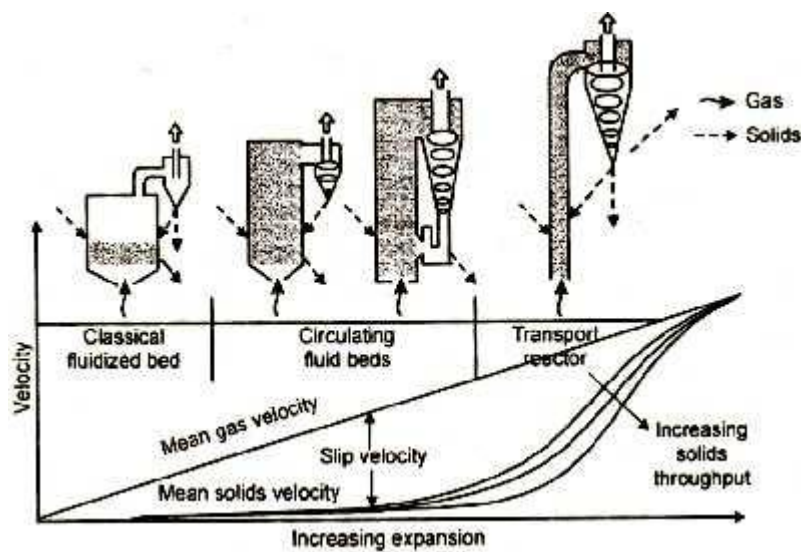
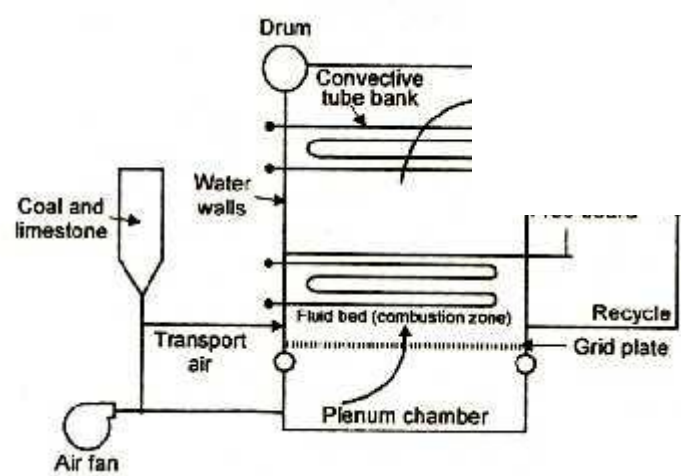

Figure: Basic fluid bed Systems



larger particles are entrained in the gas stream and well-defined for a BFB combustor becomes more difficult. A fluidized bed that is operated at velocities in the range of a fluidized bed, or CFB. A schematic of a typical

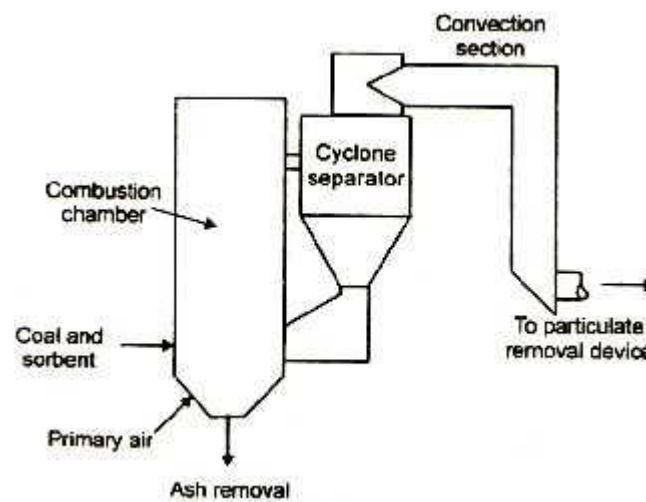

Figure: Circulating bed combustor.

Advantages of fluidized bed combustion

The advantages of FBC in comparison to conventional pulverized coal-fueled units can be summarized as follows:

1. SO₂ can be removed in the combustion process by adding limestone to the fluidized bed, eliminating the need for an external desulfurization process.
2. Fluidized bed boilers are inherently fuel flexible and, with proper design provision, can burn a variety of fuels.
3. Combustion FBC units takes place at temperatures below the ash fusion temperature of most fuels. Consequently, tendencies for slagging and fouling are reduced with FBC.
4. Because of the reduced combustion temperature, NO_x emissions are inherently low.

1.6 classification of Fluidized Bed combustion and Bubbling fluidized Bed Combustor

b) Circulating fluidized bed combustor

1.7 Classification of Fluidized Bed Combustion:

1. Atmospheric fluidized Bed Combustion (AFBC)
 - a. Bubbling fluidized bed combustors
 - b. Circulating fluidized
2. Pressurized Fluidized Bed Combustion (PFBC)

1.8 Atmospheric Fluidized Bed Combustion (AFBC)

Bubbling fluidized bed combustor

A typical BFB arrangement is illustrated schematically in figure. Fuel and sorbent are introduced either above or below the fluidized bed. (Overbed feed is illustrated.) The bed consisting of about 97% limestone or inert material and 3% burning fuel, is suspended by hot primary air entering the bottom of the combustion chamber. The bed temperature is controlled by heat transfer tubes immersed in the bed and by varying the quantity of coal in the bed. As the coal particle size decreases, as a result of either combustion or attrition, the particles are elutriated from the bed and carried out the combustor. A portion of the particles elutriated from the bed are collected by a cyclone (or multiclone) collector down-stream of the convection pass and returned to the bed to improve combustion efficiency.

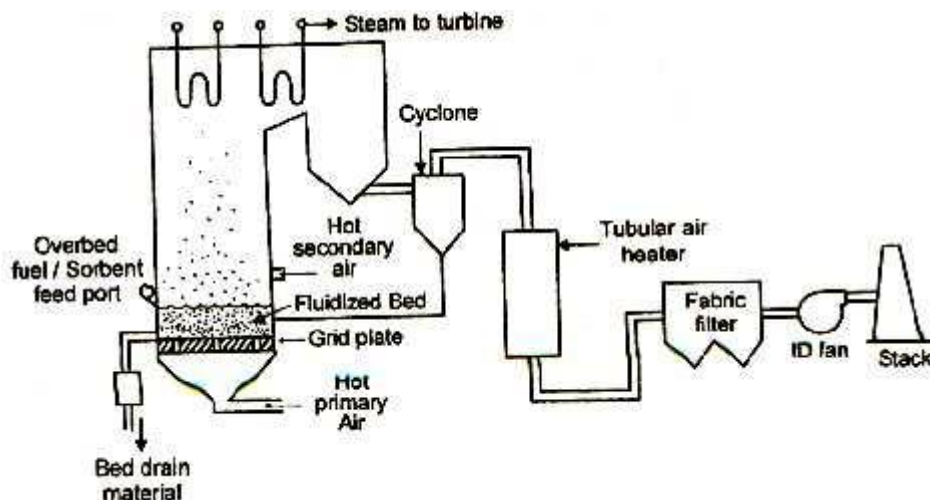

Figure: BFB Arrangement

Secondary air can be added above the bed to improve combustion efficiency and to achieve staged combustion, thus lowering NO_x emissions. Most of the early BFBs used tubular air heaters to minimize air leakage that could occur as a result of relatively high primary air pressures required to suspend the bed. Recent designs have included regenerative type air heaters.

Circulating fluidized bed combustor

A typical CFB arrangement is illustrated schematically in figure. In a CFB, primary air is introduced into the lower portion of the combustor, where the heavy bed material is fluidized and retained. The upper portion of the combustor contains the less dense material that is entrained from the bed. Secondary air typically is introduced at higher levels in the combustor to ensure complete combustion and to reduce NO_x emissions.

The combustion gas generated in the combustor flows upward with a considerable portion of the solids inventory entrained. These entrained solids are separated from the combustion gas in

hot cyclone-type dust collectors or in mechanical particle separators, and are continuously returned to the combustion chamber by a recycle loop.

The combustion chamber of a CFB unit for utility applications generally consists of membrane-type welded water walls to provide most of the evaporative boiler surface. The lower third of the combustor is refractory lined to protect the water walls from erosion in the high-velocity dense bed region. Several CFB design offer external heat exchangers, which are unfired dense BFB units that extract heat from the solids collected by the dust collectors before it is returned to the combustor. The external heat exchangers are used to provide additional evaporative heat transfer surface as well as superheat and reheat surface, depending on the manufacturer's design.

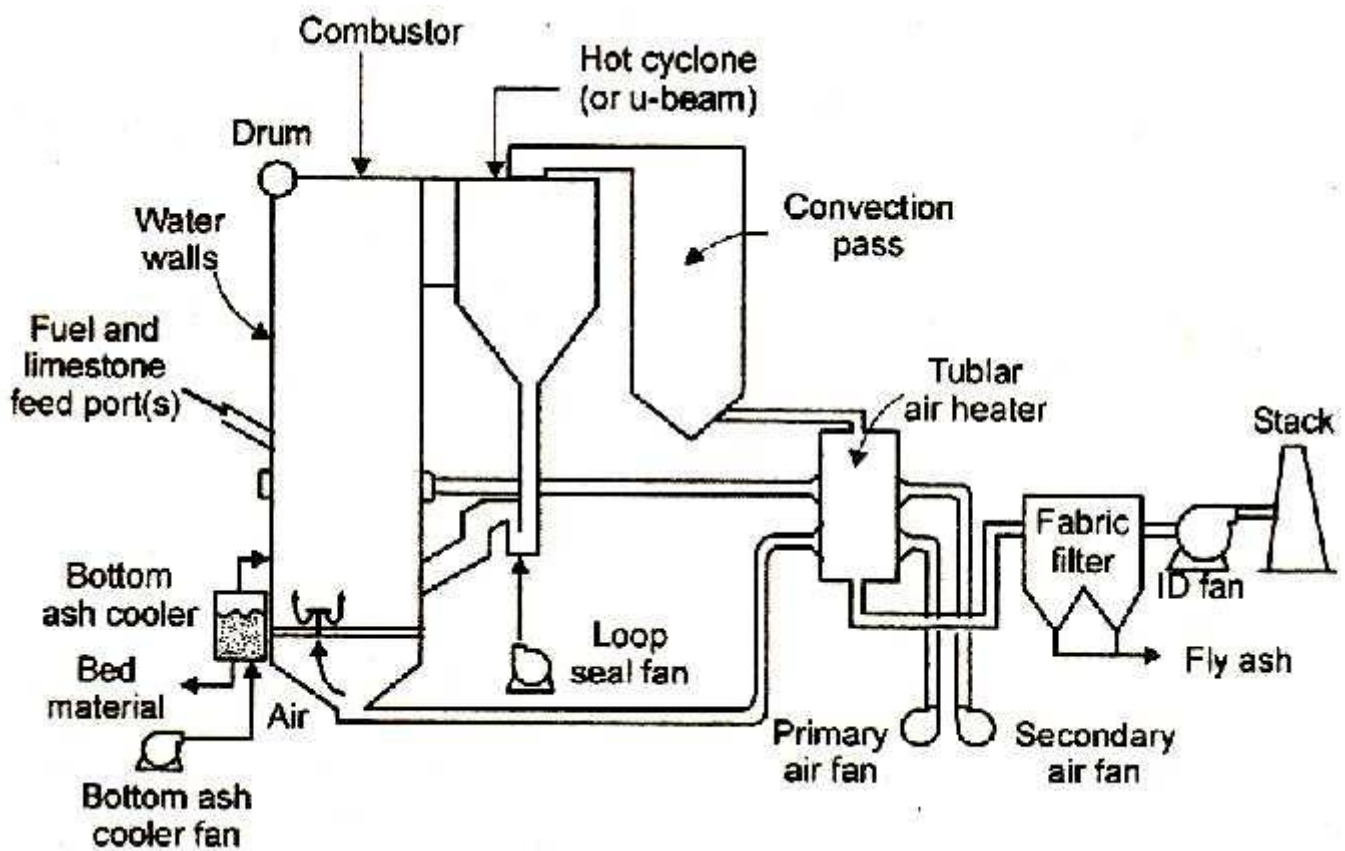

Figure: Atmospheric circulating bed combustor.

The flue gas, after removal of more than 99% of the entrained solids in the cyclone or particle separator, exists the cyclone or separator to a convection pass. The convection pass designs are similar to those used with unconvictional coal-fueled units, and contain economizer, superheat, and reheat surface as required by the application.

1.9 Pressurized fluidized Bed combustion

Pressurized Fluidized Bed Combustion:

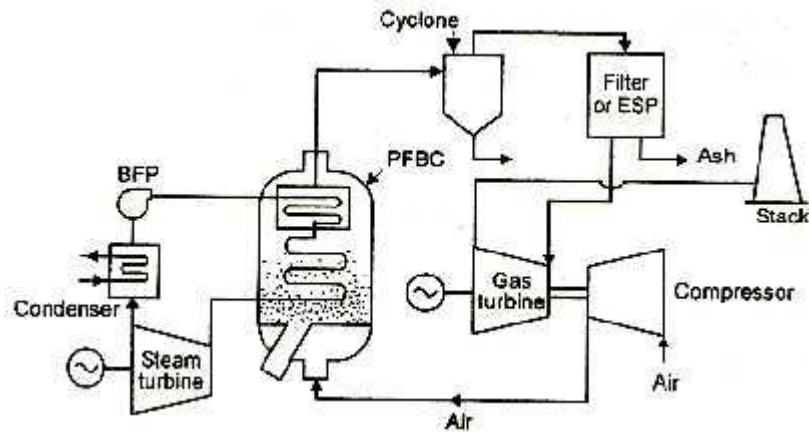

Figure: PFBC turbocharged arrangement

The PFBC unit is classified as either turbocharged or combined cycle units. In turbocharged arrangements (figure) combustion gas from the PEBC boiler is cooled to approximately 394° C and is used to drive a gas turbine. The gas turbine drives an air compressor, and there is little, if any, net gas turbine output. Electricity is produced by a turbine generator driven by steam generated in the PFBC boiler.

In the combined cycle arrangement (figure) 815°C to 871°C combustion gas from the PFBC boiler is used to drive the gas turbine. About 20% of the net plant electrical output is provided by the gas turbine. With this arrangement, thermal efficiency 2 to 3 percentage points higher than with the turbocharged cycle are feasible.

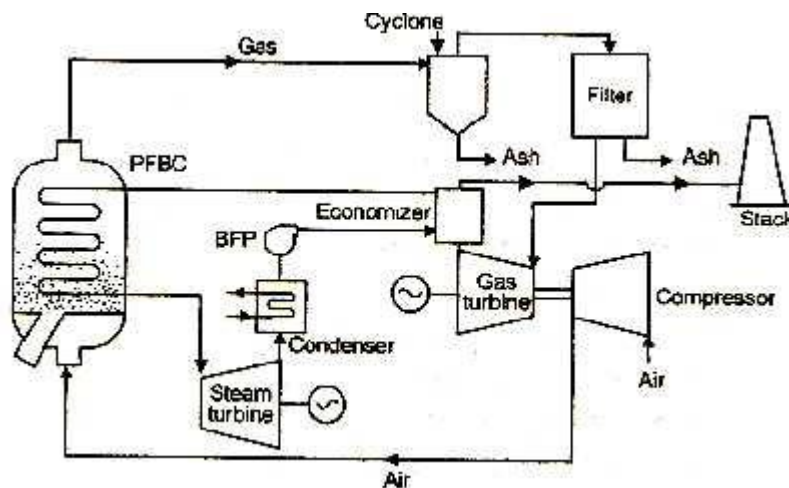

Figure: PFBC combined cycle rearrangement

1.10 steps involved in coal handling

Fuel Handling System

Coal delivery equipment is one of the major components of plant cost. The various steps involved in coal handling are as follows:

1. Coal delivery.

2. Unloading
3. Preparation
4. Transfer
5. Outdoor storage
6. Covered storage
7. Inplant handling
8. Weighing and measuring
9. Feeding the coal into furnace.

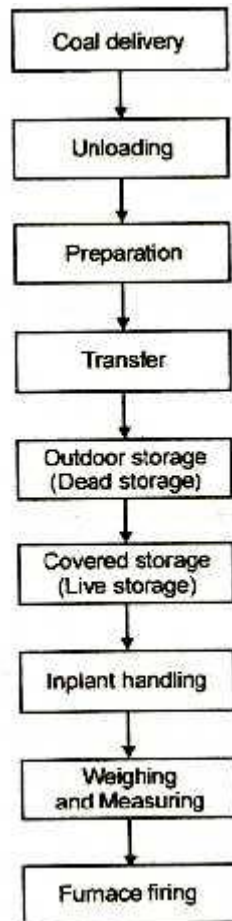

Figure: Steps involved in fuel handling system

i) Coal delivery

The coal from supply points is delivered by ships or boats to power stations situated near to sea or river whereas coal is supplied by rail or trucks to the power stations which are situated away from sea or river. The transportation of coal by trucks is used if the railway facilities are not available.

ii) Unloading

The type of equipment to be used for unloading the coal received at the power station

depends on how coal is received at the power station. If coal delivered by trucks, there is no need of unloading device as the trucks may dump the coal to the outdoor storage. Coal is easily handled if the lift trucks with scoop are used. In case the coal is brought by railways wagons, ships or boats, the unloading may be done by car shakes, rotary car dumpers, cranes, grab buckets and coal accelerators. Rotary car dumpers although costly are quite efficient for unloading closed wagons.

(iii) Preparation

When the coal delivered is in the form of big lumps and it is not of proper size, the preparation (sizing) of coal can be achieved by crushers, breakers, sizers, driers and magnetic separators.

iv) Transfer

After preparation coal is transferred to the dead storage by means of the following systems.

1. Belt conveyors
2. Screw conveyors
3. Bucket elevators
4. Grab bucket elevators
5. Skip hoists
6. Flight conveyor

1.11 Belt Conveyor

Figure: Belt Conveyor

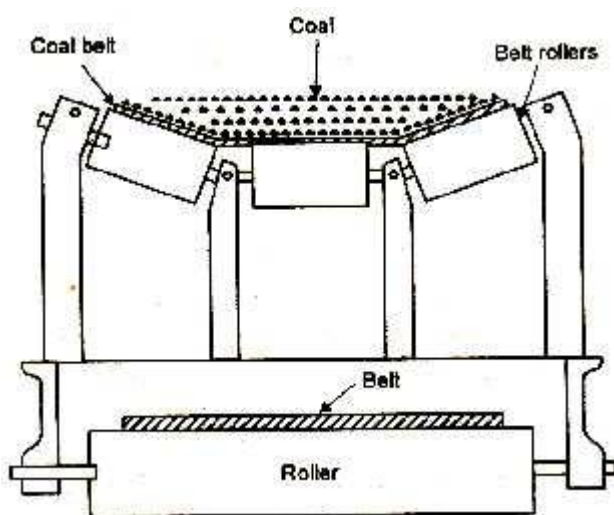

Figure shows a belt conveyor. It consists of an endless belt moving over a pair of end drums (rollers). At some distance a supporting roller is provided at the centre. The belt is made up of rubber or canvas. Belt conveyor is suitable for the transfer of coal over long distances. It is used in medium and large power plants. The initial cost of system is not high and power consumption is also low. The inclination at which coal can be successfully elevated by belt

conveyor is about 20°. Average speed preferred than other types.

Advantages of belt conveyor

1. Its operation is smooth and clean
2. It requires less power as compared to other types of systems
3. Large quantities of coal can be discharged quickly and continuously.
4. Material can be transported on moderate inclines.

2. Screw Conveyor

It consists of an endless helicoid screw fitted to a shaft (figure). The screw while rotating in a trough transfers the coal from feeding end to the discharge end.

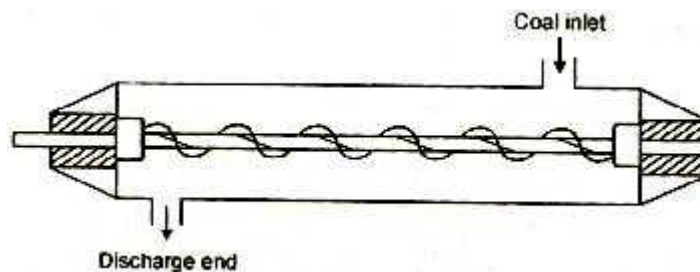

Figure: Screw conveyor

This system is suitable, where coal is to be transferred over shorter distance and space limitations exist. The initial cost of the consumption is high and there is considerable wear on screw. Rotation of screw varies between 75-125 r.p.m

3. Bucket elevator

It consists of buckets fixed to a chain (figure). The chain moves over two wheels. The coal is carried by the bucket from bottom and discharged at the top.

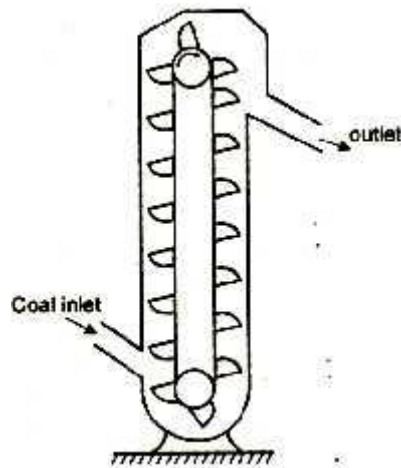

Figure: Bucket elevator

4. Grab bucket elevator

It lifts and transfers coal on a single rail or track from one point to the other. The coal lifted by grab buckets is transferred to overhead bunker or storage. This system requires less power for operation and requires minimum maintenance.

The grab bucket conveyor can be used with crane or tower as shown in figure . Although the initial cost of this system is high but operating cost is less.

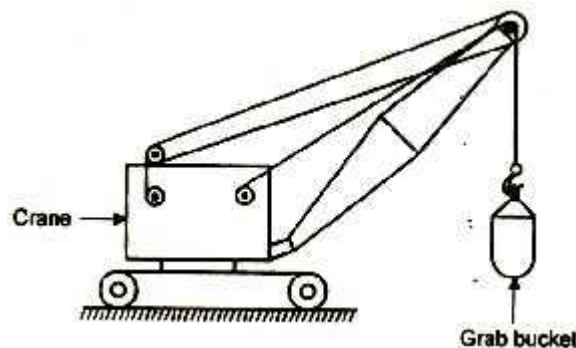

Figure: Grab bucket elevator.

Storage of Coal

It is desirable that sufficient quantity of coal should be stored. Storage of coal gives protection against the interruption of coal supplies when there is delay in transportation of coal or due to strike in coal mines. Also when the prices are low, the coal can be purchased and stored for future use. The amount of coal to be stored depends on the availability of space for storage, transportation facilities, the amount of coal that will whether away and nearness to coal mines of the power station. Usually coal required for one month operation of power plant is stored in case of power stations are situated at longer distance from the collieries whereas coal need for about 15

days is stored in case of power station situated near to collieries. Storage of coal for longer periods is not advantageous because it blocks the capital and results in deterioration of the quality of coal.

1.12 pulverized coal storage in Bunker.

Periodically a power plant may encounter the situation where coal must be stored for sometimes in a bunker, for instance during a plant shut down. The bunker, fires can occur in dormant pulverized coal from spontaneous heating within 6 day of loading. This time can be extended to 13 days when a blanket of CO₂ is piped into the top of the bunker. The perfect sealing of the bunker from air leakage can extend the storage time as two months or more. The coal in the bunker can be stored as long as six months by expelling air from above the coal with the use of CO₂ and then blanketing of all sources of air. A control system used for storing the pulverized fuel in bunker is shown in figure.

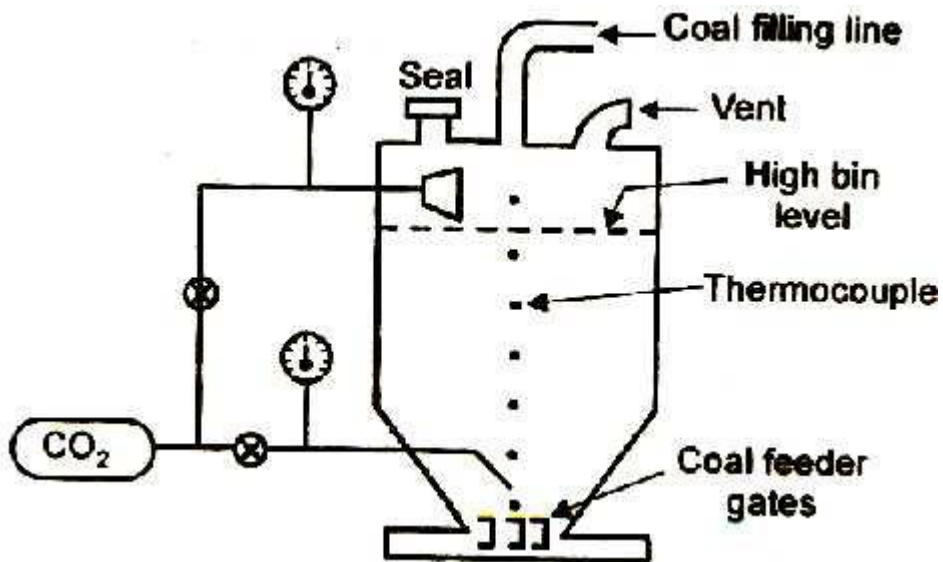

Figure : Control system used for storing the pulverized coal with the use of CO.

1.13 pulverized coal handing system and Pulverized Fuel

Handling System:

Two methods are in general use to feed the pulverized fuel to the combustion chamber of the power plant. First is 'Unit System' and second is 'Central or Bin System'.

In unit system, each burner of the plant is fired by one or more pulverizers connected to the burners, while in the central system, the fuel is pulverized in the central plant and then disturbed to each furnace with the help of high pressure air current. Each type of fuel handling system consists of crushers, magnetic separators, driers, pulverizing mills, storage bins, conveyors and feeders.

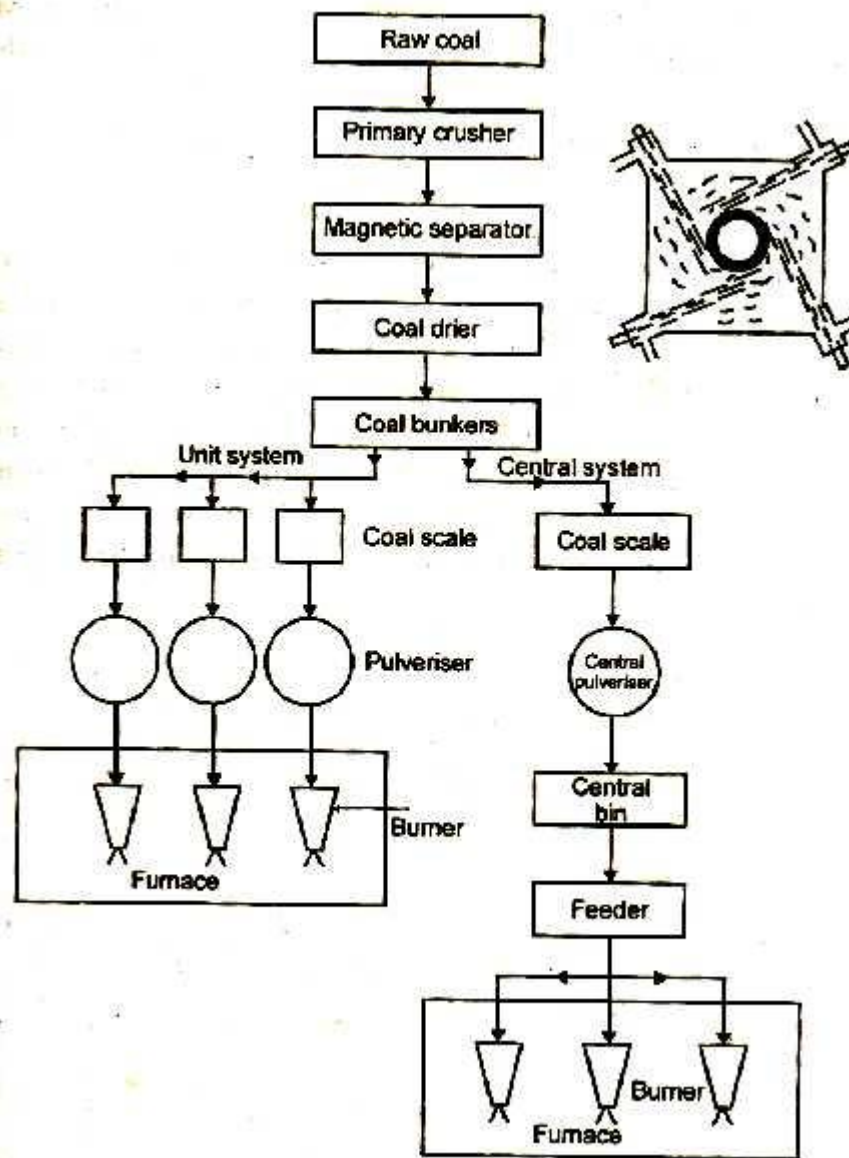

Figure: Pulverized coal handling plant showing all required equipment for unit and central system.

The arrangement of different equipment required in both systems is shown in figure. With the help of a block diagram.

The coal received by the plant from the mine may vary widely in sizes. It is necessary to make the coal of uniform size before passing the pulverizer for efficient grinding. The coal received from the mine is passed through a preliminary crusher to reduce the size to allowable limit (30 mm). The crushed coal is further passed over magnetic separator which removes pyrites and tramp iron. The further equipment through which coal is passed before passing to pulverizer are already shown in figure.

- a) Ball mill pulverizing
- b) Ball and Race mill pulverizing

a) Ball Mill

A line diagram of ball mill using two classifiers is shown in figure. It consists of a slowly rotating drum which is partly filled with steel balls. Raw coal from feeders is supplied to the classifiers from where it moves to the drum by means of a screw conveyor. As the drum rotates the coal get pulverized due to the combine impact between coal and steel balls. Hot air is introduced into the drum. The powdered coal is picked up by the air and the coal air mixture enters the classifiers, where sharp changes in the direction of the mixture throw out the oversized coal particles. The over-sized particles are returned to the drum. The coal air mixture from the classifier moves to the exhauster fan and then it is supplied to the burners.

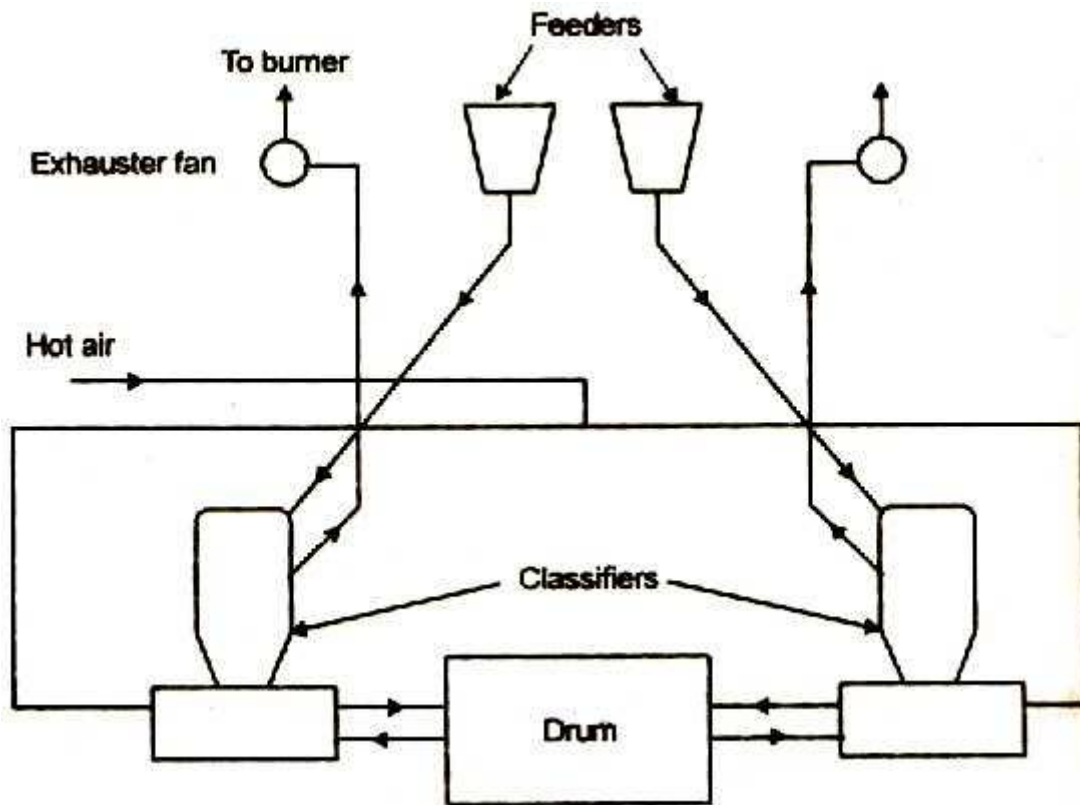

Figure: Ball mill

Ball and Race Mills

Figure: shows a ball and race mill

In this mill the coal passes between the rotating elements again and again until it has been pulverized to desired degree of fineness. The coal is crushed between two moving surfaces, namely, balls and races. The upper stationary race and lower rotating race driven by a worm and gear hold the balls between them. The raw coal supplied falls on the inner side of the races. The moving balls and races catch coal between them to crush it to a powder. The necessary force needed for crushing is applied with the help of springs. The hot air supplied picks up the coal dust as it flows between the balls and races and then enters the classifier. Where oversized coal particles are returned for further grinding. Where as the coal particles of required size are discharged from the top of classifier.

Advantages:

- i) Lower capital cost
- ii) Lower power consumption
- iii) Less space required.
- iv) Less weight

1.14 Layout of Ash handling system

Ash Handling System:

Boilers burning pulverized coal (PC) have bottom furnaces. The large ash particles are collected under the furnace in a water-filled ash hopper, Fly ash is collected in dust collectors with either an electrostatic precipitator or a baghouse. A PC boiler generates approximately 80% fly ash and 20% bottom ash. Ash must be collected and transported from various points of the plants as shown in figure. Pyrites, which are the rejects from the pulverizers, are disposed of with the bottom ash system. Three major factors should be considered for ash disposal systems.

1. Plant site
2. Fuel source
3. Environmental regulation

Needs for water and land are important considerations for many ash handling systems. Ash quantities to be disposed of depend on the kind of fuel source. Ash storage and disposal sites are guided by environmental regulations.

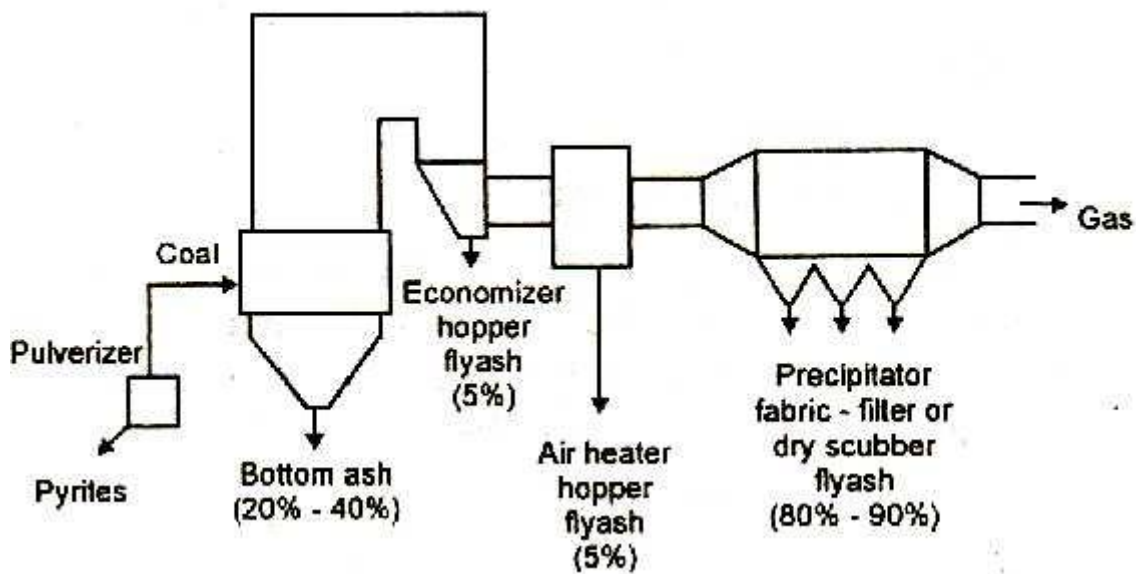

Figure: Layout of ash collection and transportation

The sluice conveyor system is the most widely used for bottom ash handling, while the hydraulic vacuum conveyor (figure) is the most frequently used for fly systems.

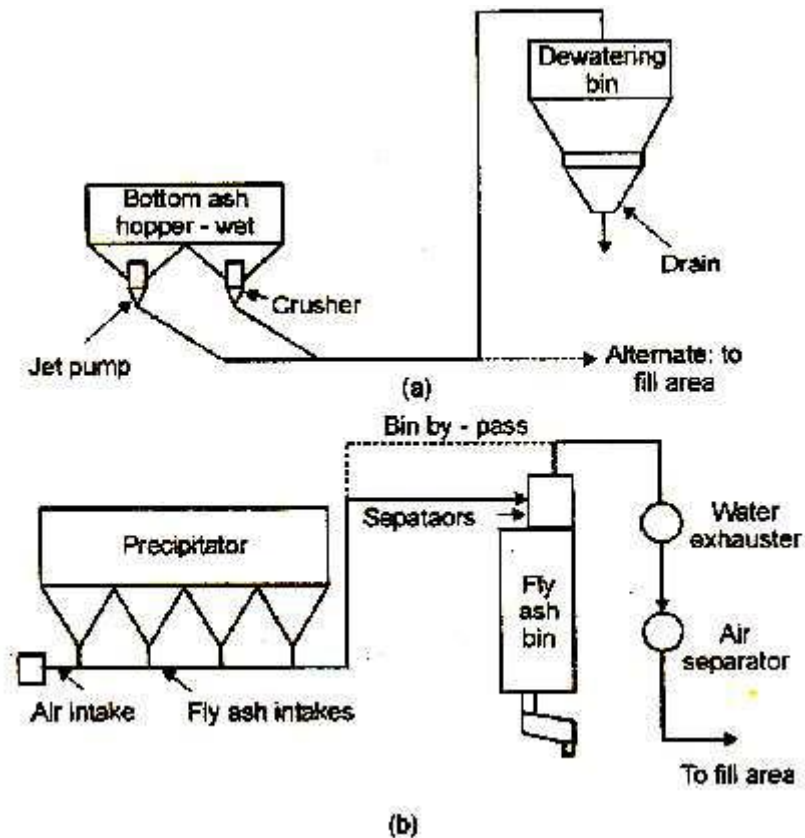

Figure: Layout of ash handling system.

Bottom and slag may be used as filling material for road construction. Fly ash can partly replace cement for making concrete. Bricks can be made with fly ash. These are durable and strong.

1.15 Ash handling Equipment

Ash Handling Equipment:

Mechanical means are required for the disposal of ash. The handling equipment should perform the following functions: 1. Capital investment, operating and maintenance charges of the equipment should be low. 2. It should be able to handle large quantities of ash. 3. Clinkers, shoot, dust etc. create troubles. The equipment should be able to handle them smoothly. 4. The equipment used should remove the ash from the furnace, load it to the conveying system to deliver the ash to dumping site or storage and finally it should have means to dispose of the stored ash. 5. The equipment should be corrosion and wear resistant.

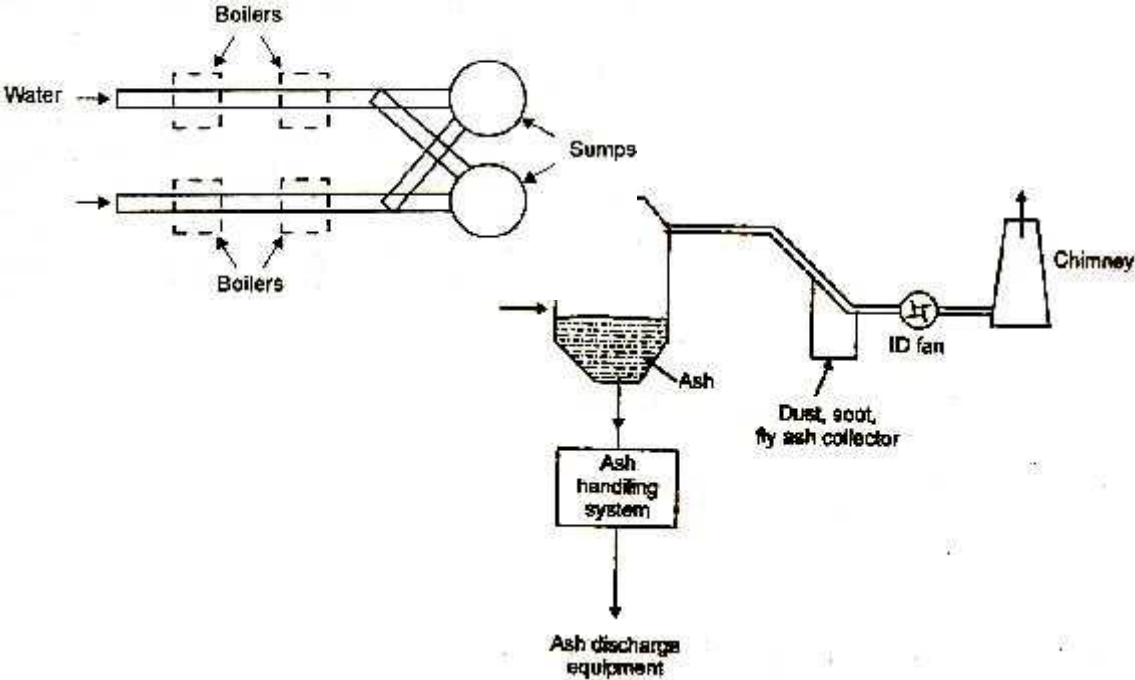

Figure: Ash handling equipment

1.16 classification of Ash handling system Classification of Ash Handling System:

- i) Hydraulic system
- ii) Pneumatic system
- iii) Mechanical system

The commonly used ash discharge equipment is as follows:

- i) Rail road cars
- ii) Motor truck
- iii) barge

Hydraulic System

In this system, ash from the furnace grate falls into a system of water possessing high velocity and is carried to the sumps. It is generally used in large power plants. Hydraulic system is of two types, namely, low pressure hydraulic system used for intermittent ash disposal figure. Figure shows hydraulic system.

Figure: Hydraulic system

In this method water at sufficient pressure is used to take away the ash to sump. Where water and ash are separated. The ash is then transferred to the dump site in wagons, rail cars to trucks. The loading of ash may be through a belt conveyor, grab buckets. If there is an ash basement with ash hopper the ash can fall, directly in ash car or conveying system.

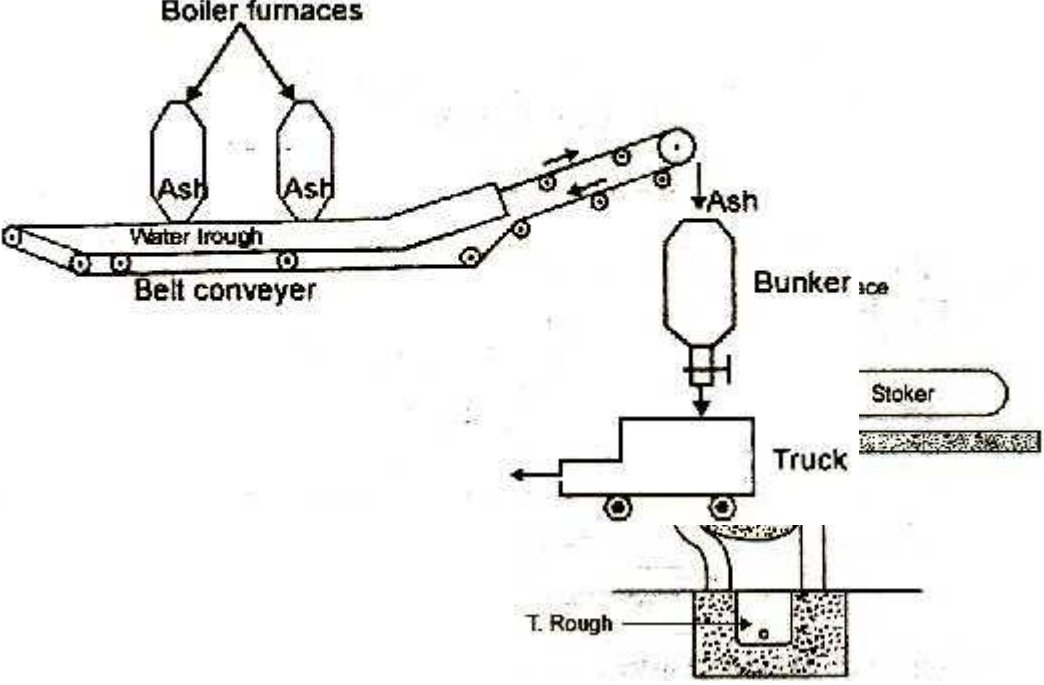

Figure: Water jetting

Water jetting of ash is shown in figure. In this method a low pressure jet of water coming out of quenching nozzle is used to cool the ash. The ash falls into trough and is then removed.

Pneumatic System

In this system ash from the boiler furnace outlet falls into a crusher where a larger ash particles are crushed to small sizes. The ash is then carried by a high velocity air or steam to the point of delivery. Air leaving the ash separator is passed through filter to remove dust etc. So that the exhauster handles clean air which will protect the blades of the exhauster.

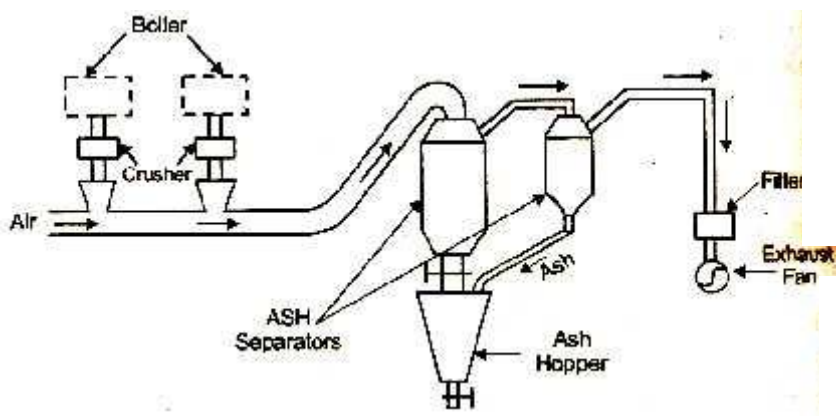

Figure: Pneumatic system

Mechanical system

Figure: Mechanical system

Figure shows a mechanical ash handling system. In this system ash cooled by water seal falls on the belt conveyor and is carried out continuously to the bunker. The ash is then removed to the dumping site from the ash bunker with the help of trucks.

1.17 Draught and Wright the types of Draught.

Draught:

Draught is defined as the difference between absolute gas pressure at any point in a gas flow passage and the ambient (same elevation) atmospheric pressure. Draught is plus if $P_{atm} < P_{gas}$ and it is minus $P_{atm} > P_{gas}$. Draught is achieved by small pressure difference which causes the flow of air or gas to take place. It is measured in millimetre (mm) or water.

The purpose of draught is as follows:

- i) To supply required amount of air to the furnace for the combustion of fuel
The amount of fuel that can be burnt per square root of grate area depends upon the quantity of air circulated through fuel bed.
- ii) To remove the gaseous products of combustion.

Classification of DRAUGHT:

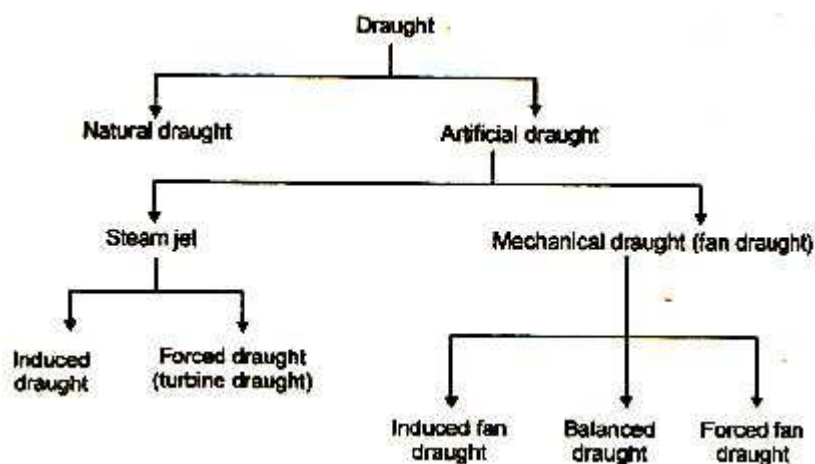

If only chimney is used to produce the draught, it is called natural draught.

Artificial Draught

If the draught is produced by steam jet or fan it is known as artificial draught

Steam jet Draught:

It employs steam to produce the draught

Mechanical draught

It employs fan or blowers to produce the draught.

Induced draught

The flue is drawn (sucked) through the system by a fan or steam jet

Forced draught

The air is forced into system by a blower or steam jet.

1.18 Natural Draught with advantages and disadvantages applications in Natural Draught:

Natural draught system employs a tall chimney as shown in figure. The chimney is a vertical tubular masonry structure or reinforced concrete. It is constructed for enclosing a column of exhaust gases to produce the draught. It discharges the gases high enough to prevent air pollution. The draught is produced by this tall chimney due to temperature difference of hot gases in the chimney and cold external air outside the chimney.

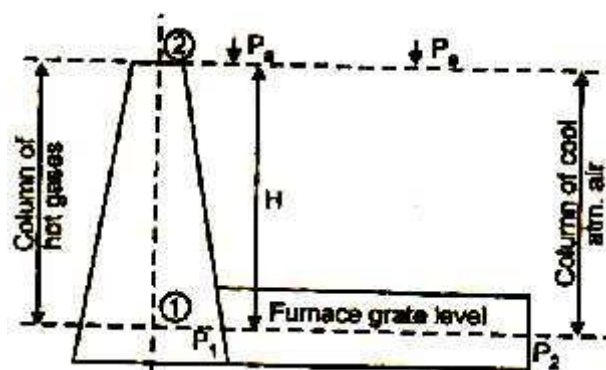

Figure: Natural draught

Where H- Height of the Chimney (m)

p_a – Atmospheric pressure (N/m²)

p₁ – Pressure acting on the grate from chimney side (N/m²)

p_2 – Pressure acting on the grate from atmospheric (N/m^2)

Due to this pressure difference (p), the atmospheric air flows through the furnace grate and the flue gases flow through the chimney. The pressure difference can be increased by increasing the height of the chimney or reducing the density of hot gases.

Merits of Natural Draught

1. No external power is required for creating the draught.
2. Air pollution is prevented since the flue gases are discharged at a higher level
3. Maintenance cost is practically nil since there are no mechanical parts.
4. It has longer life.
5. Capital cost is less than that of an artificial draught

Demerits of natural draught

1. Maximum pressure available for producing draught by the chimney is less.
2. Flue gases have to be discharged at high temperature since draught increases with the increase in temperature of flue gases.
3. Heat cannot be extracted from the flue gases for economizer, superheater, air pre-heater, etc. since the effective draught will be reduced if the temperature of the flue gases is decreased.
4. Overall efficiency of the plant is decreased since the fluid gases are discharged at higher temperatures.
5. Poor combustion and specific fuel consumption is increased since the low velocity of air affects thorough mixing of air and fuel.
6. Not flexible under peak loads since the draught available for a particular height of a chimney is constant.
7. A considerable amount of heat released by the fuel (about 20%) is lost due to flue gases.

Applications

Natural draught system is used only in small capacity boilers and it is not used in high capacity thermal plants.

1.19 Forced Draught b) Induced Draught c) Balanced Draught Artificial Draught

It has been seen that the draught produced by chimney is affected by the atmospheric conditions. It has no flexibility, poor efficiency and tall chimney is required. In most of the modern power plants, the draught used must be independence of atmospheric condition, and it

must have greater flexibility (control) to take the fluctuating loads on the plant.

Today's large steam power plants requiring 20 thousand tons of steam per hour would be impossible to run without the aid of draft fans. A chimney of an reasonable height would be incapable of developing enough draft to remove the tremendous volume of air and gases ($400 \times 10^3 \text{ m}^3$ to $800 \times 10^3 \text{ m}^3$ per minutes). The further advantage of fans is to reduce the height of the chimney needed.

The draught required in actual power plant is sufficiently high (300 mm of water) and to meet high draught requirements, some other system must be used, known as artificial draught. The artificial draught is produced by a fan and it is known as fan (mechanical) draught. Mechanical draught is preferred for central power stations.

Forced Draught

In a forced draught system, a blower is installed near the base of the boiler and air is forced to pass through the furnace, flues, economizer, air-preheater and to the stack. This draught system is known as positive draught system or forced draught system because the pressure and air is forced to flow through the system. The arrangement of the system is shown in figure. A stack or chimney is also in this system as shown in figure but its function is to discharge gases high in the atmosphere to prevent the contamination. It is not much significant for producing draught therefore height of the chimney may not be very much.

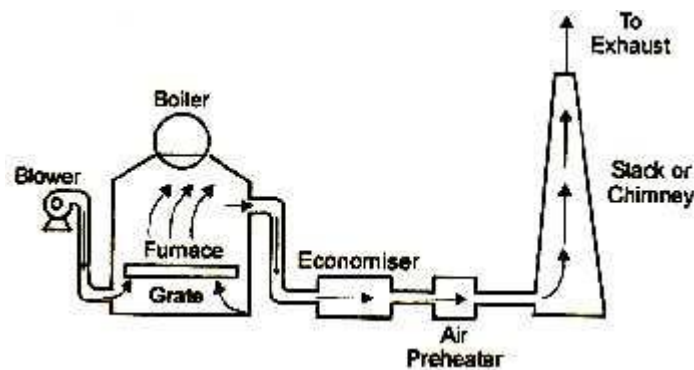

Figure: Forced draught

Induced Draught:

In this system, the blower is located near the base of the chimney instead of near the grate. The air is sucked in the system by reducing the pressure through the system below atmosphere. The induced draught fan sucks the burned gases from the furnace and the pressure inside the furnace is reduced below atmosphere and induces the atmospheric air to flow through the furnace. The action of the induced draught is similar to the action of the chimney. The draught produced is independent of the temperature of the hot gases therefore the gases may be

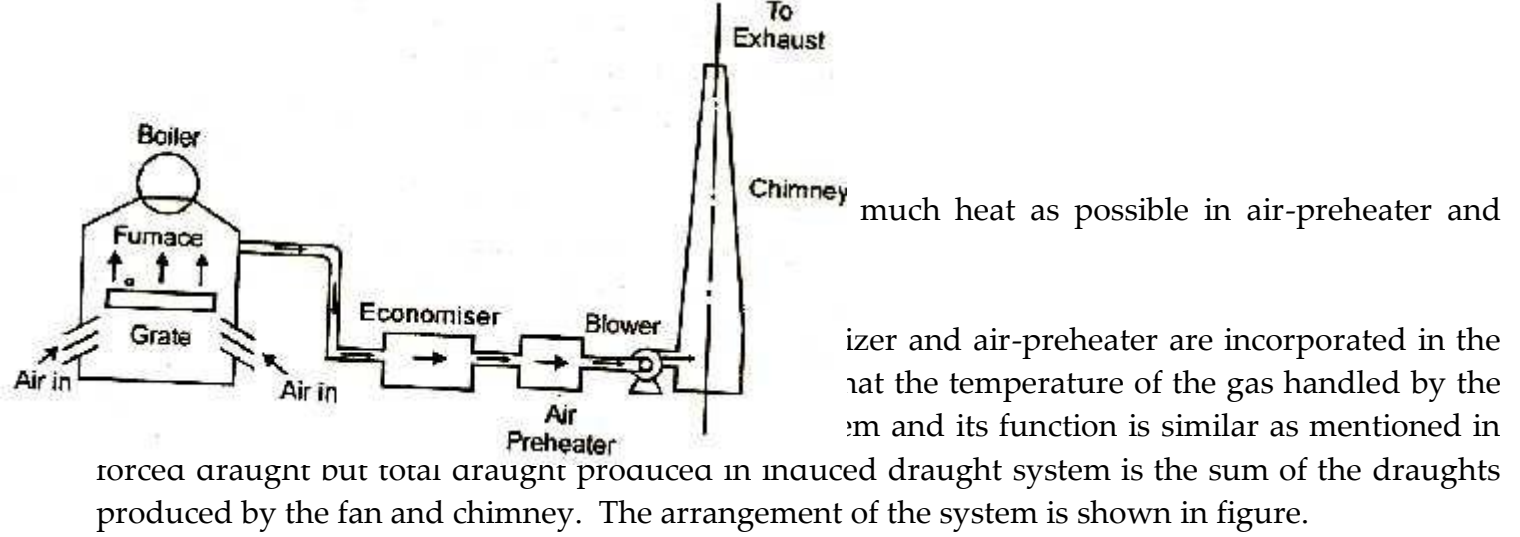

Figure: Induced draught

Balanced Draught:

It is always preferable to use a combination of forced draught and induced draught instead of forced or induced draught alone.

If the forced draught is used alone, then the furnace cannot be opened either for firing or inspection because the high pressure air inside the furnace will try to blow out suddenly and there is every chance of blowing out the fire completely and furnace stops.

If the induced draught is used alone, then also furnace cannot be opened either for firing or inspection because the cold air will try to rush into the furnace as the pressure inside the furnace is below atmospheric pressure. This reduces the effective draught and dilutes the combustion.

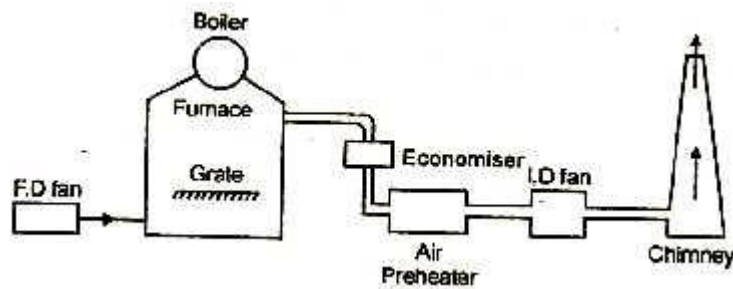

Figure: Balanced draught

To overcome both the difficulties mentioned above either using forced draught or induced draught alone, a balanced draught is always preferred. The balanced draught is a combination of forced and induced draught. The forced draught overcomes the resistance of the fuel bed therefore sufficient air is supplied to the fuel bed for proper and complete combustion. The induced draught fan removes the gases from the furnace maintaining the pressure in the furnace just below atmosphere. This helps to prevent the blow – off of flames when the doors are opened as the leakage of air is inwards.

The arrangement of the balanced draught is shown in figure. Also the pressure inside the furnace is near atmospheric therefore there is no danger of blowout or there is no danger of inrushing the air into the furnace when the doors are opened for inspection.

1.20 Compare Forced and Induced Draught?

S. No	Forced Draught	Induced Draught
1.	The size and power required by the F.D. fan is less.	The size and power required by I.D. fan is more.
2.	Volume of gas handled is less. Water cooled bearings are not required.	Volume of gas handled is more. Water cooled bearings are required to withstand high temperature flue gas.

- | | | |
|----|--|--|
| 3. | There is no chance of air leakage as the pressure inside the furnace is above atmospheric. | Continuous air leakage is possible as the pressure inside the furnace is less than atmosphere. |
| 4. | The flow of air through the grate and furnace is uniform. | Flow of air is not uniform |
| 5. | The heat transfer efficiency will be increased. | There may a chance of reduction in heat transfer efficiency. |

1.20 classification of Boilers

Classification of boilers:

The steam boilers are classified according to the following conditions

1. According to the relative position of water and hot gases	<ul style="list-style-type: none"> a. Fire tube boiler [Cochran Boiler] b. Water tube boiler [Babcock – Wilcox Boiler]
2. According to the axis of shell	

- a. Vertical boiler [Cochran Boiler]
- b. Horizontal boiler [Lancashire Boiler]

3. According to the position of boiler

- a. Internally fired boiler [all fire tube boilers] [Cochran Boilers]
- b. Externally fired boiler [all water tube boilers] [Babcock and Wilcox Boilers]

4. According to the pressure developed

- a. Low pressure boiler [Pressure less than 80 bar]
- b. High pressure boiler [Pressure greater than 80 bar]

5. According to the method of water circulation

- a. Natural circulation [all low pressure boilers] [Cochran Boiler]
- b. Forced circulation [all high pressure boilers] [LaMont Boiler]

6. According to the use of the boiler

- a. Stationary boiler [Cochran Boiler]
- b. Mobile boiler [Locomotive Boiler]

7. According to the number of drums

- a. Single
Drum
- b. Multi Drum

8. According to the nature of

- a. Natural Draught
- b. Forced Draught

1.21 Water Tube Boilers:

Babcock and Wilcox boiler:

It is a water tube boiler used in steam power plants. In this, water is circulated inside the tubes and hot gases flow over the tubes.

Description:

The Babcock and Wilcox boiler consists of

1. Steam and water drum (Boiler shell)
2. Water tubes
3. Uptake – header and down – comer
4. Grate
5. Furnace
6. Baffles
7. Superheater
8. Mud box
9. Inspection doors
10. Damper

1. Steam and Water drum (Boiler Shell)

One half of the drum which is horizontal is filled up with water and steam remains on the other half. It is about 8 metres in length and 2 metres in diameter.

2. Water tubes

Water tubes are placed between the drum and the furnace in an inclined position (at an angle of 10° to 15°) to promote water circulation. These tubes are connected to the uptake – header and the down – comer as shown.

3. Uptake – Header and Down – comer (or Down take – Header)

The drum is connected at one end to the uptake – header by short tubes and at the other end to the down – comer by long tubes.

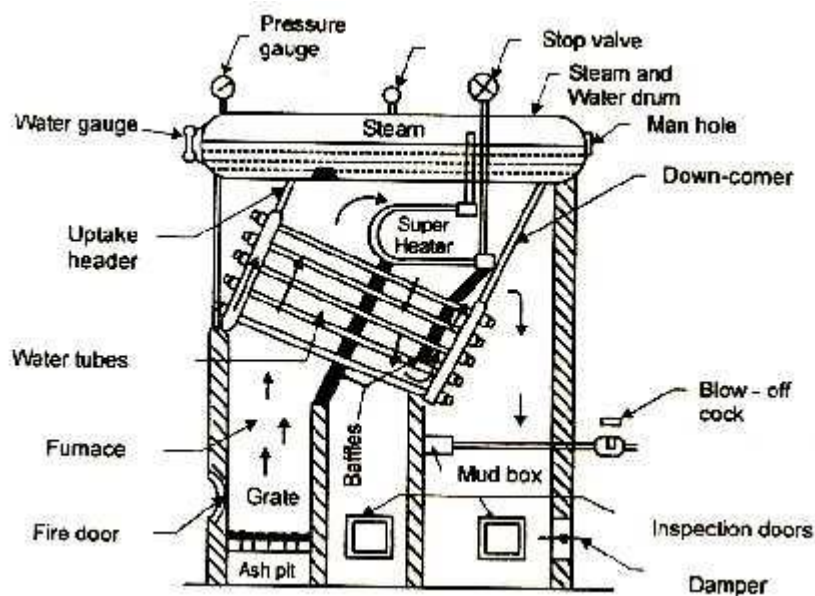

Figure: Babcock and Wilcox boiler

Grate:

Coal is fed to the grate through the fire door.

Furnace:

Furnace is kept below the uptake – header.

Baffles:

The fire – brick baffles, two in number, are provided to deflect the hot flue gases.

Superheater:

The boiler is fitted with a superheater tube which is placed just under the drum and above the water tubes.

Mud box:

Mud box is provided at the bottom end of the down – comer. The mud or sediments in the water are collected in the mud box and it is blown – off time by means of a blow – off cock.

Inspection doors:

Inspection doors are provided for cleaning and inspection of the boiler.

Working principle:

Coal is fed to grate through the fire door and is burnt.

Flow of flue gases:

The hot flue gases rise up ward and pass across the left – side portion of the water tubes. The baffles deflect the flue gases and hence the flue gases travel in a zig – zag manner (i.e., the hot gases are deflected by the baffles to move in the upward direction, then downward and again in the upward direction) over the water tubes and along the superheater. The flue gases finally escape to the atmosphere through the chimney.

A continuous circulation of water from the drum to the water tubes and water tubes to the drum is thus maintained. The circulation of water is maintained by convective currents and is known as “natural circulation”.

Superheating:

Steam is taken from the steam space of the drum through a tube to the superheater. Steam is superheated in the superheater, as it receives additional heat.

A damper is fitted as shown regulate the flue gas outlet and hence the draught.

The boiler is fitted with necessary mountings. Pressure gauge and water level indicator are mounted on the boiler at its left end. Steam safety valve and stop valve are mounted on the top of

the drum. Blow – off cock is provided for the periodical removal of mud and sediments collected in the mud box.

Salient features:

1. Its overall efficiency is higher than a fire tube boiler.
2. The defective tubes can be replaced easily.
3. All the components are accessible for inspection even during the operation.
4. The draught loss is minimum compared with other boilers.
5. Steam generation capacity and operating pressure are high compared with other boilers.
6. The boiler rests over a steel structure independent of brick work so that the boiler may expand or contract freely.
7. The water tubes are kept inclined at an angle of $10^{\circ} - 15^{\circ}$ to promote water circulation.

Water tube boiler over fire tube boilers:

Advantages:

1. Steam can be generated at very high pressures.
2. Heating surface is more in comparison with the space occupied. In the case of water tube boilers.
3. Steam can be raised more quickly than is possible with a fire tube boiler of large water capacity. Hence, it can be more easily used for variations of load.
4. The hot gases flow almost at right angles to the direction of water flow. Hence maximum amount of heat is transferred to water.
5. A good and rapid circulation of water can be made.
6. Bursting of one or two tubes does not affect the boiler very much with regard to its working. Hence water tube boilers are sometimes called "safety boilers".
7. The different parts of a water tube boiler can be separated. Hence it is easier to transport.
8. It is suitable for use in steam power plants (because of the various advantages listed above).

Disadvantages:

1. It is less suitable for impure and sedimentary water, as a small deposit of scale may cause the overheating and bursting of tubes. Hence, water treatment is very essential for water tube boilers.
2. Maintenance cost is high.
3. Failure in feed water supply even for a short period is liable to make the boiler overheated. Hence the water level must be watched very carefully during operation of a water tube boiler.

1.22 working principle of Economizer and Air pre – heater?

Boiler Accessories:

Economizer:

Function:

An economizer pre – heats (raise the temperature) the feed water by the exhaust flue gases. This pre – heated water is supplied to the boiler from the economizer.

Location:

An economizer is placed in the path of the flue gases in between the boiler and the air pre – heater or chimney.

Construction:

An economizer used in modern high pressure boilers is shown by a line sketch. It consists of a series of vertical tubes. These tubes are hydraulically pressed into the top and bottom headers. The bottom header is connected to feed pump. Top header is connected to the water space of the boiler. It is provided with a safety valve which opens when water pressure exceeds a certain limit. To keep the surface of the tubes clean from soot and ash deposits, scrapers are provided in the tubes. These scrapers are slowly moved up and down to clean the surfaces of the tubes. The action of adjacent pairs of scraper is in opposite direction. i.e., when one scraper moves up, the other moves down.

Economizers may be parallel or counter-flow types. When the gas flow and water flow are in the same direction, it is called parallel flow economizer. In counter-flow, the gas flow and water flow are in opposite direction.

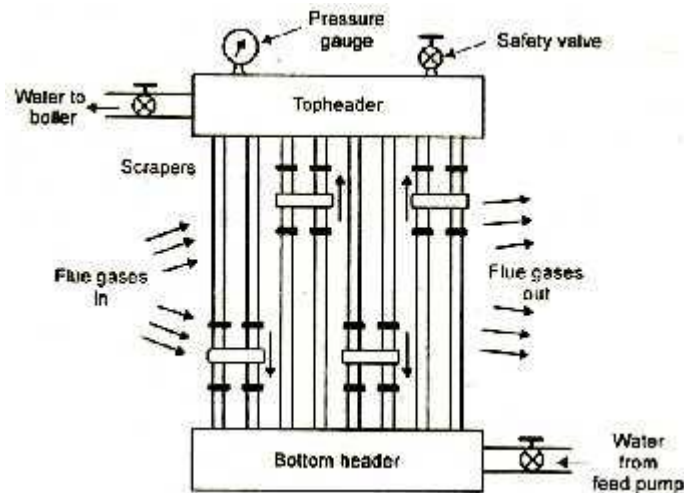

Fig. Economizer

Working

The feed water is pumped to the bottom header and this water is carried to the top header through a number of vertical tubes. Hot flue gases are allowed to pass over the external surface of the tubes. The feed water which flows upward in the tubes is thus heated by the flue gases. This pre-heated water is supplied to the boiler.

Advantages

1. Feed water to the boiler is supplied at high temperature. Hence heat required in the boiler is less. Thus fuel consumption is less.
2. Thermal efficiency of the plant is increased.
3. Life of boiler is increased.
4. Loss of heat in flue gases is reduced.
5. Steaming capacity is increased.

Air pre-heater

Function

Air pre-heater pre-heats (increases the temperature) the air supply to the furnace with the help of hot the gases.

Location

It is installed between the economizer and the chimney.

Construction

A tubular type air pre-heater is shown in figure. It consists of a large number of tubes. Flue gases pass through the tube. Air flows over the tubes. Baffles are provided to pass the air number of times over the tubes. A soot hopper is provided at the bottom to collect the soot.

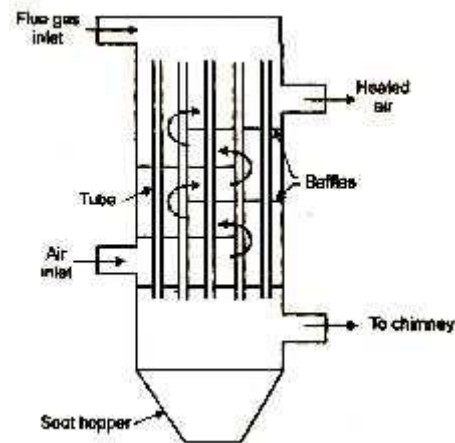

Figure: Air pre-heater

Working

Hot flue gases pass through the tubes of air pre-heater after leaving the boiler or economizer. Atmospheric air is allowed to pass over these tubes. Air and flue gases flow in opposite directions. Baffles are provided in the air pre-heater and the air passes number of times over the tubes. Heat is absorbed by the air from the flue gases. This pre-heater air is supplied to the furnace to air combustion.

Advantages

1. Boiler efficiency is increased.
2. Evaporative rate is increased.
3. Combustion is accelerated with less soot, smoke and ash.
4. Low grade and inferior quality fuels can be used.

1. Super heater
2. Injector
3. Feed pump
4. Steam separators
5. Steam trap

1. Super heater

Function

It superheats the steam generated by the boiler and increases the temperature steam above saturation temperature at constant pressure.

Location

Superheaters are placed in the path of flue gases to recover some of their heat. In bigger installations, the superheaters are placed in an independently fired furnace. Such superheaters are called separately fired or portable superheaters.

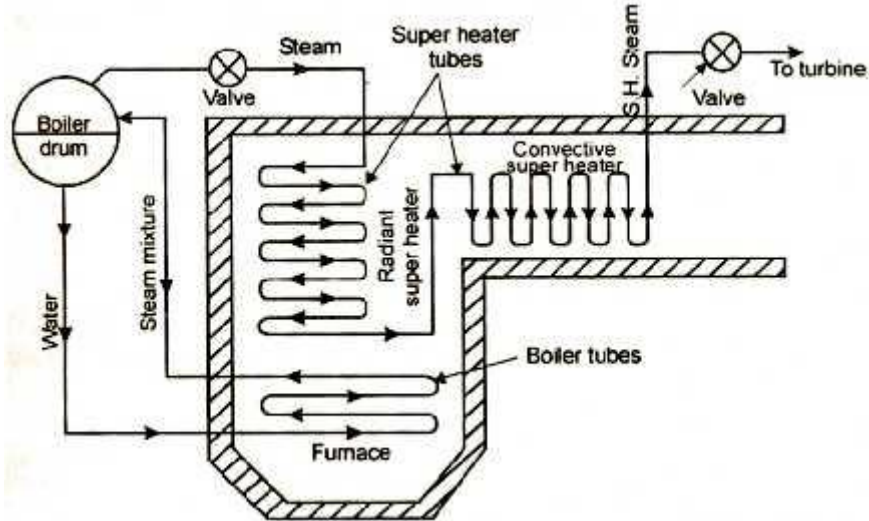

Fig Super heater (radiant and convective)

Construction

There are many types of superheaters. A combination type of radiant and convective superheater is shown in figure. Both these superheaters are arranged in series in the path of flue gases. Radiant superheater receives heat from the burning fuel by radiation process. Convective superheater is placed adjacent to the furnace wall in the path of flue gases. It receives heat by convection.

Working

Steam stop valve is opened. The steam (wet or dry) from the evaporator drum is passed through the superheater tubes. First the steam is passed through the radiant superheater and then to the convective superheater. The steam is heated when it passes through these superheaters and converted into superheated steam. This superheated steam is supplied to the turbine through a valve.

Applications

This type of superheaters are used in modern high pressure boilers.

Advantages of superheated steam (super heaters)

1. Work output is increased for the same quantity of steam.
2. Loss due to condensation of steam in the steam engine and in the steam mains is

minimized.

3. Capacity of the plant is increased.
4. Thermal efficiency is increased since the temperature of superheated steam is high.

2.Injector

Function

An injector lifts and forces water into a boiler which is operating under pressure.

Construction

It consists of a converging nozzle, mixing chamber, divergent tube, steam valve and a non-return valve. A steam injector is shown in figure.

Working

The steam passes through the converging nozzle through a valve. Steam expands through the nozzle. The pressure drops and consequently velocity of steam increases. This steam mixes with water in the mixing chamber. In the mixing chamber steam condenses and vacuum is created. Due to this vacuum, more water is sucked into the mixing chamber. The jet water enters divergent tube. In the divergent tube kinetic energy of water is converted into pressure energy. Due to this increased pressure, feed water is forced into the boiler through feed check valve.

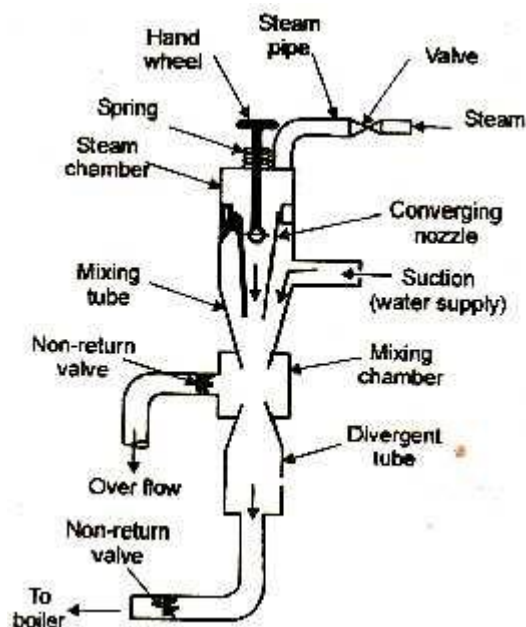

Figure: Steam injector

Application

They are commonly used in vertical and locomotive boilers.

3. Feed pump

Function

It delivers feed water into the boiler drum.

Location

It is placed in between boiler and water supply source (hot well).

Construction

The feed pumps used may be of reciprocating type or rotary type (centrifugal pump). The reciprocating pump may use plunger or piston. It is driven by a steam engine or electric motor. The piston rod of the steam engine is connected directly with the piston rod of the pump (figure).

Working

When the piston moves to the right, vacuum is created in the left side of the piston. The water from the hot well is forced into the cylinder through the left side suction valve. When the piston returns (moves to the left), vacuum is created in the right side of the piston. The liquid from the well is sucked into the cylinder through the right side suction valve. At the same time, the liquid in the left side of the piston is forced out through the left side delivery valve into the delivery pipe. The operations are repeated. During each stroke, suction takes place on one side of the water is delivered continuously in the boiler.

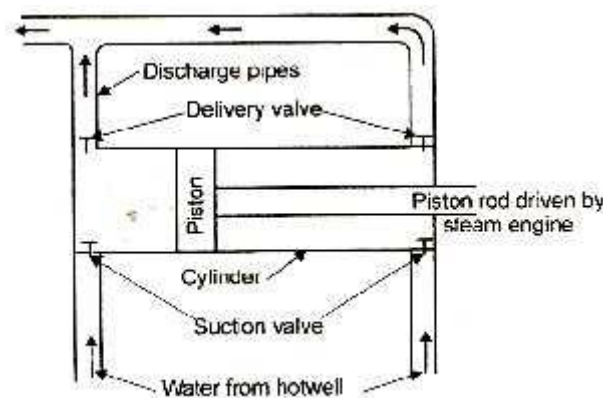

Figure: Feed pump (reciprocating type).

4. Steam separators (Steam Driers)

Function

It separates water particles from steam before it is supplied to a steam engine or turbine. Thus it prevents the damaging of turbine blades due to moisture present in steam.

Location

It is located in the supply line near the turbine or engine.

Construction

There are different types of steam separators. A separator with baffle plates is shown in figure. It consists of a cylindrical vessel. The vessel is fitted with baffle plates. A water gauge is fitted to indicate the water collected in the separator to drain away to separated water.

Working

The steam is allowed into the separator. The steam strikes the baffle plates and the direction of the flow is changed. As a result, heavier water particles in steam falls down to the bottom of the separator. The separated steam is free from water particles. It is passed to the turbine or engine through the outlet pipe.

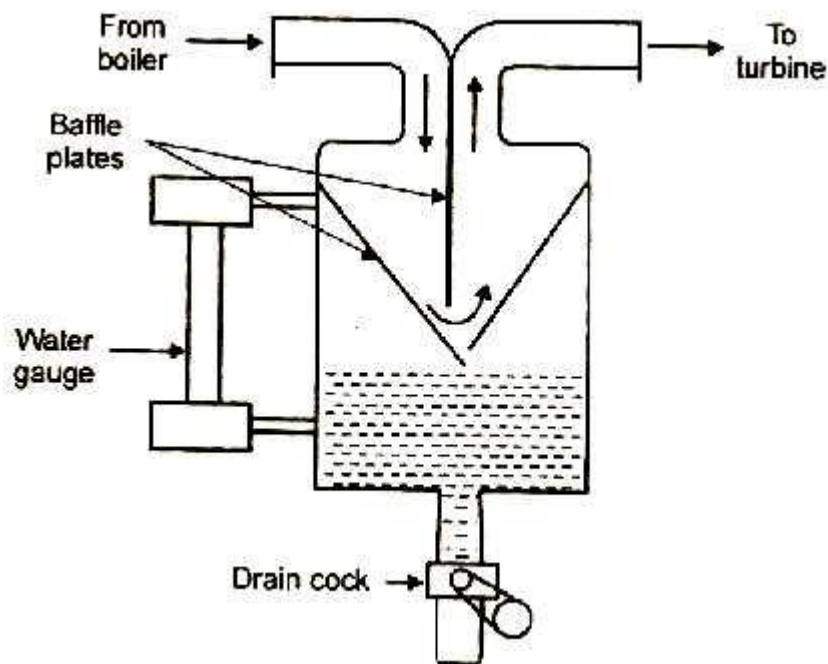

Figure: Steam separator

5. Steam trap

Function

In any steam system, water may be formed due to partial condensation of steam in the piping system. This may cause water hammer and reduction in efficiency. A steam trap removes the condensed water, without allowing the steam to escape out.

Construction

Figure: Ball float steam trap

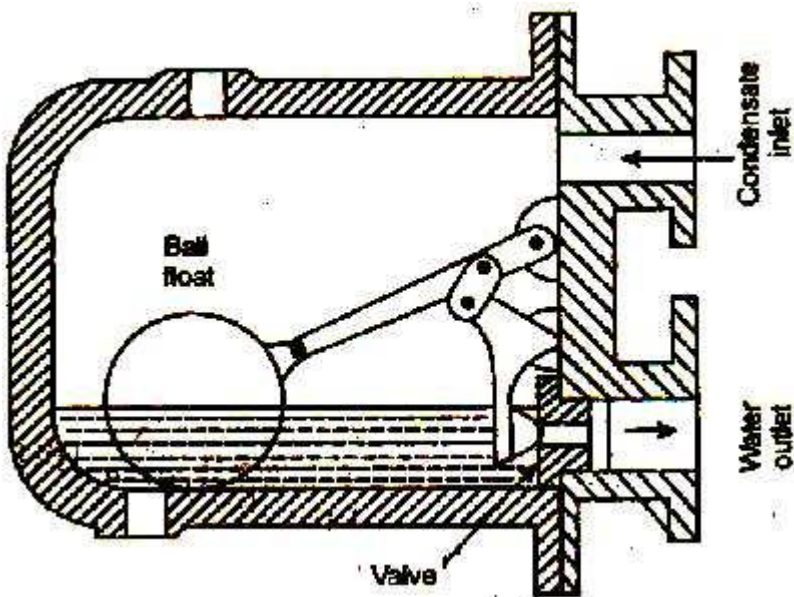

F

Location

They are located on the steam mains, headers etc.

Working

The condensed water enters the steam trap by gravity. When the water level in the trap rises high enough, the ball float is lifted. This causes the valve to open and the water is discharged through the outlet. After the discharge of water, the float moves down. This causes the valve to close again.

1.23 open cycle and closed cycle condensing system.

A condenser is a device in which the steam is condensed by cooling it with water. The condensed steam is known as condensate. The following are the advantages of installing a condenser in a steam power plant.

1. More work is done by the given amount of steam than could be obtained without a condenser. Thus, the efficiency of the power plant is increased.
2. Steam consumption is reduced for the given output.
3. The condensate is recovered for the boiler feed water.

The steam power plants using condenser are shown in figure shows that the cooling water used in condenser is not re-circulated again and again but discharged to the downstream side of

the river. Whereas figure shows that the cooling water is re-circulated again and again by passing through the cooling tower.

The essential elements of a steam condensing plant is given below:

1. A closed vessel in which the steam is condensed.
2. A pump to deliver condensed steam to the hot well from the condenser.
3. A dry air-pump to remove air and other non-condensable gases.
4. A feed pump to deliver water to the boiler from hot well.
5. Another pump for circulating cooling water.
6. An arrangement for re-cooling the circulating water from the condenser such as cooling tower or spray pond.

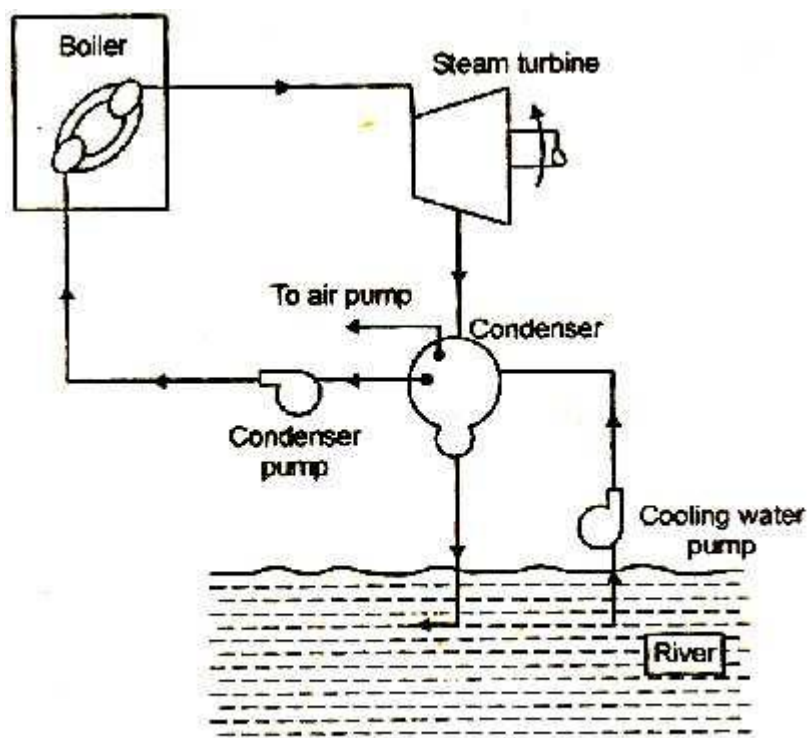

(a) Open cycle condensing system

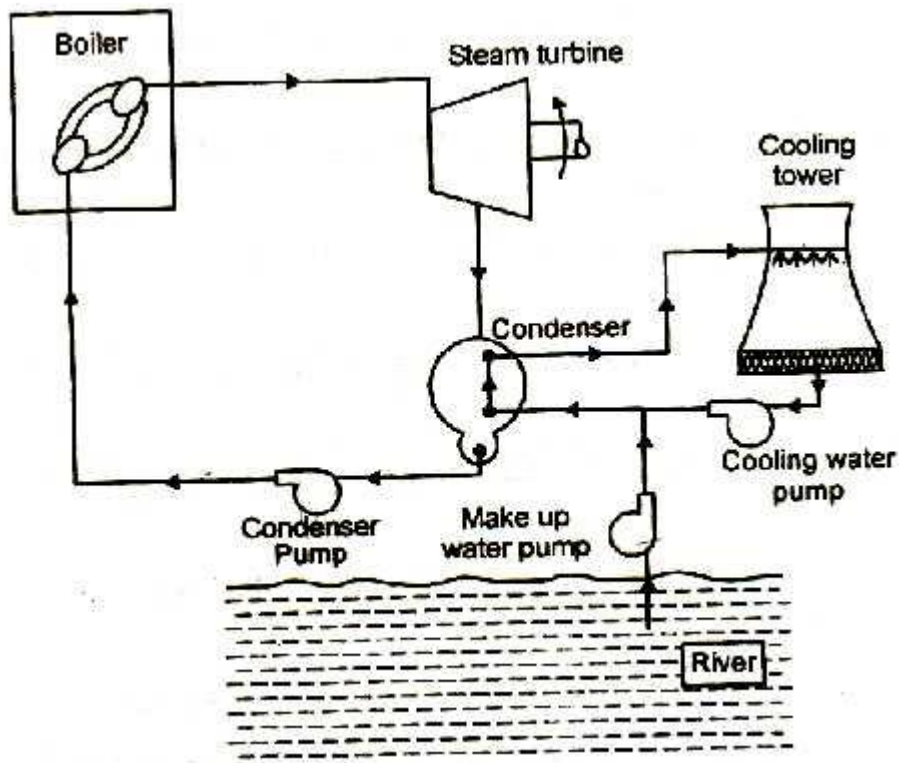

Figure: (b) Closed cycle condensing system

1.24 Classification of condensers?

Condensers are classified as follows:

In jet condensers, the steam to be condensed.

In surface condensers, the steam which is to be condensed.

In parallel flow condensers, the steam and cooling water flow in the same direction.

In counter flow jet condensers, the steam and cooling water flow in opposite directions.

In low level jet condensers, the condensate falls to the hot well by the barometric leg provided in the condenser.

In high level jet condensers, the condensate falls to the hot well by the barometric leg provided in the condenser.

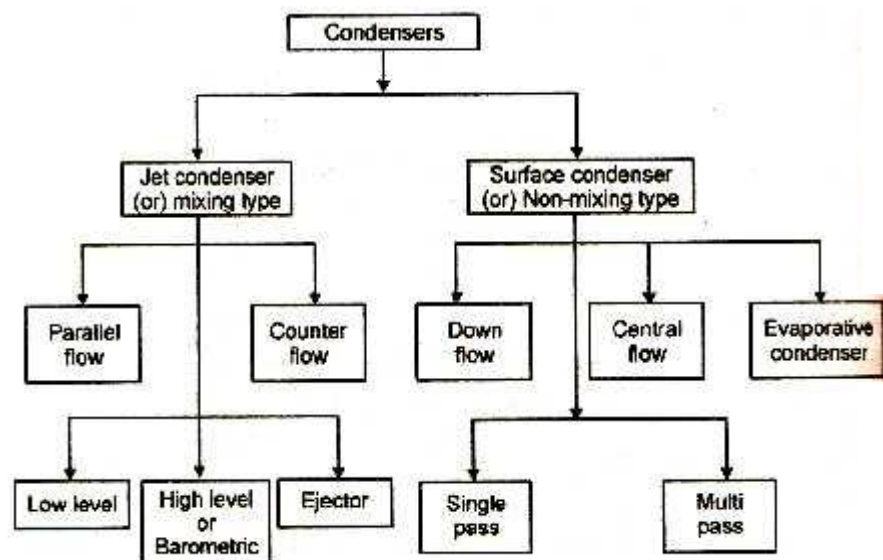

m which is

l the steam

u the same

ctions.

pump into

In ejector condensers, a number of convergent nozzles are used.

In down flow surface condensers, the condensed steam flows down from the condenser.

In central flow surface condensers, the condensed steam moves towards the centre of condenser tubes.

In single pass surface condensers, the cooling water flows in the condenser tubes only once.

In multi pass surface condensers, the cooling water flows in the condenser tubes number of times.

8. Differentiate propeller and Kaplan turbine?

In the propeller turbine the runner blades are fixed and non-adjustable. In Kaplan turbine, which is a modification of propeller turbine the runner blades are adjustable and can be rotated about the pivots fixed to the boss of the runner.

9. What are the Element of Hydel Power Plant?

Elements of Hydel Power Plant:

1. Water reservoir,
2. Dam,
3. Spillway,
4. Pressure tunnel,
5. Penstock,
6. Surge tank,
7. Water turbine,
8. Draft tube,
9. Tail race,

10. Step-up transformer,
11. Power house.

10. Write the Advantages of Hydro-electric power plants?

1. Water is a renewable source of energy. Water which is the operating fluid, is neither consumed nor converted into something else,
2. Water is the cheapest source of energy because it exists as a free gift of nature. The fuels needed for the thermal, diesel and nuclear plants are exhaustible and expensive.
3. There is no ash disposal problem as in the case of thermal power plant.

11. Write the classification of Hydro turbines?

Hydraulic turbines are classified as follows:

- 1) According to the head and quantity of water available,
- 2) According to the name of the originator,
- 3) According to the action of water on the moving blades,
- 4) According to the direction of flow of water in the runner,
- 5) According to the disposition of the turbine shaft,
- 6) According to the specific speed N .

12. Define Governing Mechanism?

When the load on the turbine changes, the speed may also change. (i.e., without load the speed increases and with over load, the speed decreases). Hence, the speed of the runner must be maintained constant to have a constant speed of generator. This is done by controlling the quantity of water flowing on the runner according to the load variations. This speed regulation is known as governing and it is usually done automatically by a governor.

13. What are the functions of draft tubes?

- 1) Increase in efficiency,
- 2) Negative head.

14. Write the two types of Draft tubes?

The draft tubes are of the following three types:

- 1) Conical or divergent draft tube,
- 2) Elbow type draft tube,
- 3) Hydracone or Moody spreading draft tube.

15. Define Kaplan turbine?

The Kaplan turbine is an axial flow reaction turbine. It is suitable for relatively low heads. Hence, it requires a large quantity of water to develop high power. It operates in an entirely

closed conduct from the head race to the rail race.

16. Write the advantages of small Hydro-power plant (SHP)?

- a) Readily accessible source of renewable energy,
- b) Can be installed making use of water head as low as 2 m and above,
- c) Does not involve setting up of large dams,
- d) Least polluting.

2.1 Working principle

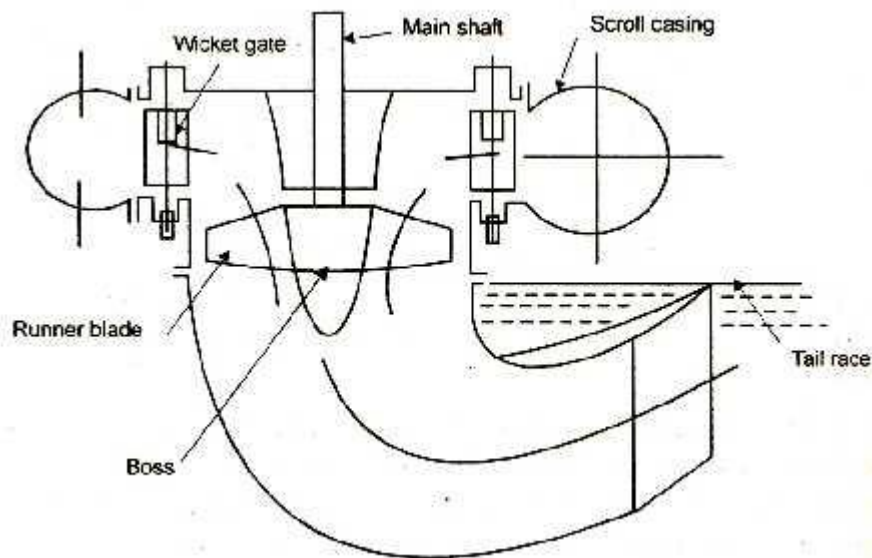

Figure: Kaplan turbine

The water from the scroll casing flows over the guide vanes. It is deflected through 90° between guide vanes and runner. Then, it flows axially into the runner. The blades are shaped such that water flows axially in the runner. The force exerted on the blades causes the runner shaft to rotate. This rotation is transmitted to the generator which is couple to the runner shaft. After passing through the runner, the water enters the tailrace through a draft tube.

2.2 Governing of Kaplan turbine

A Kaplan turbine has adjustments in both guide vanes and runner vanes. Generally, double regulators are provided in a Kaplan turbine. The governor regulates the guide blade opening as well as the runner vane angles simultaneously. The adjustment of guide vanes is similar to that of a Francis turbine. The runner vanes are regulated by a separate Servomotor. The control valves for both the runner and guide vanes are interconnected to ensure a define runner vane angle for the given vane opening.

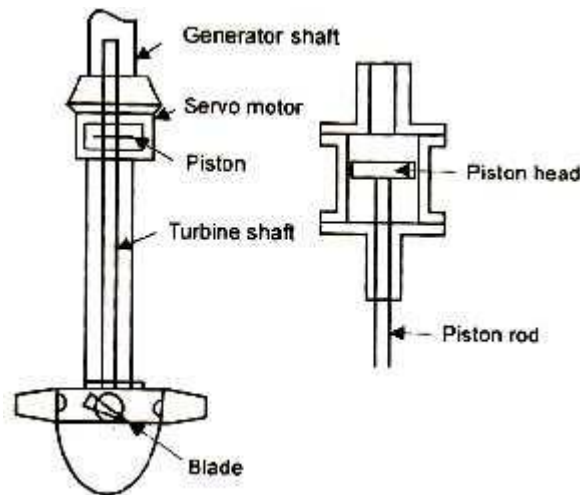

Figure: Governing of Kaplan turbine.

The runner vane angles may be adjusted while the turbine is in motion. The piston rod of the servomotor (of the runner vanes) pass through the hollow turbine shaft as shown in figure. The movement of the piston is transmitted to the runner of the piston is transmitted to the runner vane by a small crank connected to cross head. The servomotor acts as the coupling between the turbines shaft and the generator shaft. Oil from the governor is admitted to the upper or lower side of the servomotor piston through pipes. This will reduce or increase the blade angle. The governor actuates simultaneously both the guide vane and the runner vane. Thus for all loads, the turbine is able to maintain high efficiency.

2.3 Compare Impulse and reaction turbines

S.No	Impulse turbine	Reaction turbine
1.	Head: The machine is suitable for high installation. ($H=100 + 200$ m).	The machines can be used for medium heads ($H=50$ to 500 m) and low heads (less than 50 m)
2.	Nature of input energy to the runner: The nozzle converts the entire hydraulic energy into kinetic energy before water strikes the runner.	The head is usually inadequate to produce high velocity jet. Hence water is supplied to the runner in the forms of both pressure and kinetic energy.
3.	Method of energy transfer: The buckets of the runner are so shaped that they extract almost all the kinetic energy of the jet.	The wicket gates accelerate the flow a little and direct the water to runner vanes to which energies of water are transferred.
4.	Operating pressure: The turbine works under atmospheric pressure. Which is the difference between the inlet and exit points of the runner.	The runner works is a closed system under the action of reaction pressure.

5.	Admission of water to the wheel: Only a few buckets comprising a part of the wheel are exposed to the water jet.	The entire circumference of the wheel receives water and all passages between the runner blades are always full of water.
6.	Discharge: They are essential low discharge turbines.	Since power is a product of head and weight of the rate of flow, these turbines consume large quantities of water in order to develop a reasonable power under a relatively low head.
7.	Speed of operation: The speed are invariably high.	Although the specific speeds of these turbines is high, their actual running speeds are comparatively low.
8.	Size : These are generally small size.	The turbines sizes is much larger than impulse wheels, in order to accommodate heavy discharge.
9.	Casing: It prevents splashing of water. It has no hydraulic function to serve.	The spiral casing has an important role to play; it distributes water under the available pressure uniformly around the periphery of the runner.
10.	Turbine setting: The head between the wheel and race is lost.	The draft tube ensures that the head of water below tail race level is not lost.

11.	Maximum efficiency: The highest efficiency (=88%) is less than that of reaction turbine.	The maximum efficiency (=95%) of design output is higher than that of impulse wheels.
12.	Part load operation: From about 20% to 100% of design output, the efficiency remains nearly the same. Hence the machine is ideal for generating small loads over long periods of time.	With the exception of a Kaplan turbine, all reaction turbines give poor part load performance i.e., appreciably low efficiency at less than design output.
13.	Cavitation: These machine are not susceptible to cavitation.	Runner blades and draft tube invariably undergo cavitation on damage.
14.	Civil engineering works: Civil works like excavation and concreting are much simpler and economical.	Civil works are more expensive on account of spiral casing and draft tube.

2.4 construction and working principle of pumped storage plants



Figure: Pumped storage plant.

Pumped storage plants are employed at the places where the quantity of water available for power generation is inadequate. Here the water passing through the turbines is store in 'tail race pond'. During low load periods this water is pumped back to the head reservoir using the extra energy available. This water can be again used for generating power during peak load periods. Pumping of water may be done seasonally or daily depending upon the conditions of the site and the nature of the load on the plant.

Such plants are usually interconnected with steam or diesel engine pants so that off peak capacity of interconnecting stations is used in pumping water and the same is used during peak load periods. Of course, the energy available from the quantity of water pumped water the power available is reduced on account of losses occurring in prime movers.

Advantages:

The pump storage plants entail the following advantages :

1. There is substantial increase in peak load capacity of the plant at comparatively low capital cost.
2. Due to load comparable to rated load on the plant, the operating efficiency of the plant is high.
3. There is an improvement in the load factor of the plant.
4. The energy available during peak load periods is higher than that of during off peak periods so that inspite of losses incurred in pumping there is over-all gain.
5. Load on the hydro-electric plant remains uniform.
6. The hydro-electric plant becomes partly independent of the stream flow conditions.

Under pump storage projects almost 70 percent power used in pumping the water can be recovered. In this field the use of "Reversible Turbine Pump" units is also worth noting. These units can be used as turbine while generating power and as pump while pumping water to storage. The generator in this case works as motor during reverse operation. The efficiency in such case is high and almost the same in both the operations. With the use of reversible turbine pump sets, additional capital investment on pump and its motor can be saved and the scheme can be worked more economically.

UNIT – III

PART – A

1. Define Isotopes?

Those pairs of atoms which have the same atomic number and hence similar chemical properties but different atomic mass number are called isotopes.

2. Define Isobars?

Those atoms which have the same mass number but different atomic numbers are called isobars. Obviously, these atoms belong to different chemical elements.

3. Define Isomers?

Those pairs of atoms (nuclides) which have the same atomic number and atomic mass number but have different radioactive properties are called isomers and their existence is referred to as nuclear isomerism.

4. Define isotones?

Those atoms whose nuclei have the same number of neutrons are called isotones.

5. Define Radioactivity?

The phenomenon of spontaneous emission of powerful radiations exhibited by heavy element is called radioactivity. The radioactivity may be natural or artificial.

6. Write the types of Nuclear radiations?

The five types of nuclear radiations are :

- (i) Gamma rays (or photons) : electromagnetic radiation.
- (ii) Neutrons : uncharged particles, mass approximately 1.
- (iii) Protons : + 1 charged particles, mass approximately 1.
- (iv) Alpha particles : helium nuclei, charge + 2, mass 4.
- (v) Beta particles : electrons (charge – 1), positrons (charge + 1), mass very small.

7. Define Fertile Materials?

It has been found that some materials are not fissionable by themselves but they can be converted to the fissionable materials, these are known as fertile materials.

8. Define Fission?

Fission is the process that occurs when a neutron collides with the nucleus of certain of heavy atoms, causing the original nucleus to split into two or more unequal fragments which carry-off most of the energy of fission as kinetic energy. This process is accompanied by the emission of neutrons and gamma rays.

9. Define chain reaction?

A chain reaction is that process in which the number of neutrons keeps on multiplying rapidly (in geometrical progression) during fission till whole the fissionable material is disintegrated. The multiplication or reproduction factor (K) is given by:

$$K = \frac{\text{No. of neutrons in any particular generation}}{\text{No. of neutrons in the preceding generation}}$$

If $K > 1$, chain reaction will continue and if $K < 1$, chain reaction cannot be maintained.

10. Define Nuclear fusion?

Nuclear fusion is the process of combining or fusing two lighter nuclei into a stable and heavier nuclide. In this case large amount of energy is released because mass of the product nucleus is less than the masses of the two nuclei which are fused.

11. Define Nuclear Reactor?

A nuclear reactor is an apparatus in which nuclear fission is produced in the form of a controlled self-sustaining chain reaction.

12. Write the Essential components of a nuclear reactor?

Essential components of a nuclear reactor are:

- (i) Reactor core
- (ii) Reflector
- (iii) Control mechanism

- (iv) Moderator
- (v) Coolants
- (vi) Measuring instruments
- (vii) Shielding.

13. What are the main components of a nuclear power plant?

The main components of a nuclear power plant are:

- (i) Nuclear reactor
- (ii) Heat exchanger (steam generator)

- (iii) Steam turbine
- (iv) Condenser
- (v) Electric generator

14. Mention some important reactors?

Some important reactors are :

- (i) Pressurized water reactor (PWR)
- (ii) Boiling water reactor (BWR)
- (iii) Gas-cooled reactor
- (iv) Liquid metal-cooled reactor
- (v) Breeder reactor.

15. What are the factors are consider to selecting the site for Nuclear power plant?

Following factors should be considered while selecting the site for a nuclear power plant:

- (i) Proximity to load centre
- (ii) Population distribution
- (iii) Land use
- (iv) Meteorology
- (v) Geology
- (vi) Seismology
- (vii) Hydrology

16. Write the types of Reactors?

1. On the basis of neutron energy.
2. On the basis of fuel used.

3. On the basis of Moderate used.
4. On the basis of coolant used.

17. What are the advantages of nuclear power plant?

1. It can be easily adopted where water and coal resources are not available.
2. The Nuclear power plant requires very small quantity of fuel. Hence fuel transport cost is less.
3. Space requirement is very less compared to other power plant of equal capacity.
4. It is not affected by adverse weather condition.

18. Mention any 3 fast breeder reactors?

1. Liquid Metal
2. Helium
3. Carbon dioxide

19. What are the ways the liquid wastes are dispose?

1. Dilution
2. Concentration to small volumes and storages.

20. Write the effects of Nuclear radiation?

Biological damage

1. Ionization
2. Displacement
3. Absorption

3.1 short notes (a) Fission Energy (b) Chain Reaction (c) Fusion Energy

A nuclear power plant is similar to a conventional steam power plant except how that energy is evolved. The heat is produced in the nuclear power plant by fission, whereas in steam and gas turbine plants, the heat is produced by combustion in the furnace. The nuclear reactor acts as a furnace where nuclear energy is evolved by splitting or fissioning of the nucleus of fissionable material like Uranium U-235. It is claimed that 1 kg U-235 can produce as much heat energy that can be produced by burning 4500 tones of high grade coal or 1700 tons of oil.

Fission energy

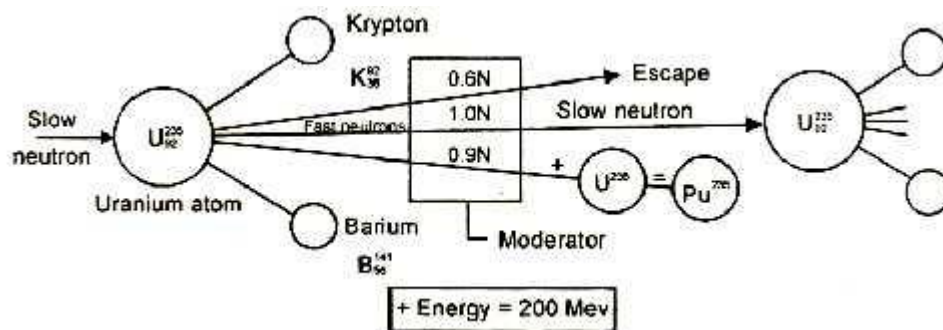

Figure : Nuclear fission

Nuclear energy is divided from splitting (or) fissioning of the nucleus of fissionable

material like Uranium U-235. Uranium has several isotopes (Isotopes are atoms of the same element having different atomic masses) such as U-234, U-235 and U-238. Of the several isotopes, U-235 is the most unstable isotope, which is easily fissionable and hence used as fuel in an atomic reactor.

When a neutron enters the nucleus of an unstable U-235, the nucleus splits into two equal fragments (Krypton and Barium) and also releases 2.5 fast moving neutrons with a velocity of 1.5×10^7 m/sec and along with this produces a large amount of energy, nearly 200 million electrovolts. This is called nuclear fission.

1. Chain reaction

The neutrons released during fission are very fast and can be made to initiate the fission of other nuclei of U-235, thus causing a chain reaction. When a large number of fission occurs, enormous amount of heat is generated, which is used to produce steam.

The chain reaction under controlled conditions can release extremely large amount of energy causing "atomic explosion"

Energy released in chain reaction, according to Einstein law is

$$E = mc^2$$

Where E = Energy liberated (J)
m = Mass (kg)
c = Velocity of light (3×10^8 m/sec).

Out of 2.5 neutrons released in fission of each nucleus of U-235, one neutron is used to sustain the chain reaction, about 0.9 neutron is captured by U-238, which gets converted into fissionable material Pu-239 and about 0.6 neutron is partially absorbed by control rod materials, coolant and moderator.

If thorium is used in the reactor core, it gets converted to fissionable material U-233.



Pr-239 and U-233 so produced are fissionable materials are called secondary fuels. They can be used as nuclear fuels. U-238 and Th-232 are called fertile materials.

2. Fusion energy

Energy is produced in the sun and stars by continuous fusion reactions in which four nuclei of hydrogen fuse in a series of reactions involving other particles that continually appear and disappear in the course of the reaction, such as He³, nitrogen, carbon, and other nuclei, but

culminating in one nucleus of helium of two positrons.

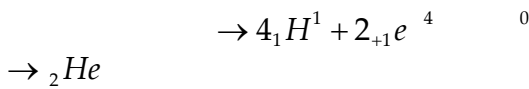

To cause fusion, it is necessary to accelerate the positively charged nuclei to high kinetic energies, in order to overcome electrical repulsive forces, by raising their temperature to hundreds of millions of degrees resulting in plasma. The plasma must be prevented from contacting the walls of the container, and must be confined for a period of time (of the order of a second) at a minimum density. Fusion reactions are called thermonuclear because very high temperatures are required to trigger and sustain them. Table lists the possible fusion reactions and the energies produced by them. n, p, D, and T are the symbols for the neutron, proton, deuterium (H^2), and tritium (H^3), respectively.

Number	Fusion reaction		Energy per reaction MeV
	Reactants	Products	
1	D + D	T + p	4
2	D + D	$\text{He}^3 + \text{n}$	3.2
3	T + D	$\text{He}^4 + \text{n}$	17.6
4	$\text{He}^3 + \text{D}$	$\text{He}^4 + \text{p}$	18.3

Many problems have to be solved before an artificially made fusion reactor becomes a reality. The most important of these are the difficulty in generating and maintaining high temperatures and the instabilities in the medium (plasma), the conversion of fusion energy to electricity, and many other problems of an operational nature.

3.2 types of Reactors

The nuclear reactors are classified on the following basis:

1. On the basis of neutron energy

a) Fast reactors

In these reactors, the fission is effected by fast neutrons without any use of moderators.

b) Thermal reactors

In these reactors, the fast neutrons are slowed with the use of moderators. The slow neutrons are absorbed by the fissionable fuel and chain reaction is maintained. The moderator is the most essential component in these reactors.

2. On the basis of fuel used

a) Natural fuel

In this reactor, the natural uranium is used as fuel and generally heavy water or graphite is used as moderator.

b) Enriched uranium

In this reactor, the Uranium used contains 5 to 10% U^{235} and ordinary water can be used as moderator.

3. On the basis of moderator used

- a) Water moderated
- b) Heavy water moderated

- c) Graphite moderated
- d) Beryllium moderated

4. On the basis of coolant used

- a) Water cooled reactors (ordinary or heavy),
- b) Gas cooled reactors
- c) Liquid metal cooled reactors
- d) Organic liquid cooled reactors

3.3 construction and working principle of Pressurized Water Reactor (PWR)

Pressurized Water Reactor (PWR):

Working principle:

A nuclear power plant differs from a conventional steam power plant only in the steam generating part. There is no change in the turbo-alternator and the condensing system.

The nuclear fuel which is at present in commercial use is Uranium. Heat energy evolved by the fission reaction of one kg of U^{235} can produce as much energy as can be produced by burning 4500 tons of high grade coal.

Uranium exists in the isotopic form of U^{235} which is unstable. When a neutron enters the nucleus of U^{235} , the nucleus splits into two equal fragments and also releases 2.5 fast moving neutrons with a velocity of 1.5×10^7 metres / sec producing a large amount of energy, nearly 200 millions electron-volts. This is called "nuclear fission".

Chain reaction

The neutrons released during the fission can be made to fission other nuclei of U^{235} causing a “chain reaction. A chain reaction produces enormous amount of heat, which is used to produce steam”.

The chain reaction under uncontrolled conditions can release extremely large amounts of energy causing “atomic explosion”.

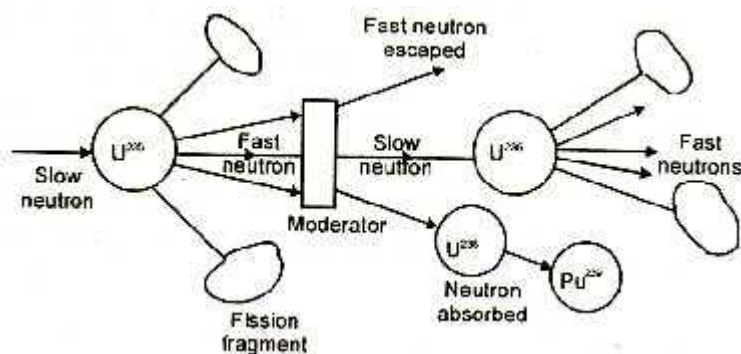

Figure: Nuclear fission.

Energy liberated in chain reaction, according to Einstein Law, is $E = mc^2$, where E = energy liberated, m = mass in grams, c = speed of light = 3×10^{10} cm/sec.

Out of 2.5 neutrons released in fission of each nuclei of U^{235} , one neutron is used to sustain the chain reaction, 0.9 neutron is converted into fissionable material Pu^{239} and 0.6 neutron is absorbed by control rod and coolant moderator.

Function of the moderator is to reduce the energy of neutrons evolved during fission in order to maintain the chain reaction. The moderators which are commonly used are ordinary water and heavy water.

3.4 block diagram of Nuclear power plant and write few advantages and disadvantages.

Main components of nuclear power plants:

i) Moderators

In any chain reaction, the neutrons produced are fast moving neutrons. These are less effective in causing fission of U^{235} and they try to escape from the reactor. It is thus implicit that speed of these neutrons must be reduced if their effectiveness in carrying out fission is to be increased. This is done by making these neutrons collide with lighter nuclei of other materials, which does not absorb these neutrons but simply scatter them. Each collision causes loss of energy and thus the speed of neutrons is reduced. Such a material is called a ‘Moderator’. The neutrons thus slowed down are easily captured by the fuel element at the chain reaction proceeds

slowly.

ii) Reflectors

Some of the neutrons produced during fission will be partly absorbed by the fuel elements, moderator, coolant and other materials. The remaining neutrons will try to escape from the reactor and will be lost. Such losses are minimized by surrounding (lining) the reactor core with a material called a reflector which will reflect the neutrons back to the core. They improve the neutron economy. Economy: Graphite, Beryllium.

iii) Shielding

During Nuclear fission α , β , γ particles and neutrons are also produced. They are harmful to human life. Therefore it is necessary to shield the reactor with thick layers of lead, or concrete to protect both the operating personnel as well as environment from radiation hazards.

iv) Cladding

In order to prevent the contamination of the coolant by fission products, the fuel element is covered with a protective coating. This is known as cladding.

Control rods are used to control the reaction to prevent it from becoming violent. They control the reaction by absorbing neutrons. These rods are made of boron or cadmium. Whenever the reaction needs to be stopped, the rods are fully inserted and placed against their seats and when the reaction is to be started the rods are pulled out.

v) Coolant

The main purpose of the coolant in the reactor is to transfer the heat produced inside the reactor. The same heat carried by the coolant is used in the heat exchanger for further utilization in the power generation.

Some of the desirable properties of good coolant are listed below

1. It must not absorb the neutrons.
2. It must have high chemical and radiation stability
3. It must be non-corrosive.
4. It must have high boiling point (if liquid) and low melting point (if solid)
5. It must be non-oxidising and non-toxic.

The above-mentioned properties are essential to keep the reactor core in safe condition as well as for the better functioning of the content.

6. It must also have high density, low viscosity, high conductivity and high specific heat. These properties are essential for better heat transfer and low pumping power.

The water, heavy water, gas (He, CO₂), a metal in liquid form (Na) and an organic liquid are used as coolants.

The coolant not only carries large amounts of heat from the core but also keeps the fuel assemblies at a safe temperature to avoid their melting and destruction.

vi) Nuclear reactor

A nuclear reactor may be regarded as a substitute for the boiler fire box of a steam power plant. Heat is produced in the reactor due to nuclear fission of the fuel U²³⁵. The heat liberated in the reactor is taken up by the coolant circulating through the core. Hot coolant leaves the reactor at top and flows into the steam generator (boiler).

Radiation hazards and Shieldings

The reactor is a source of intense radioactivity. These radiations are very harmful to human life. It requires strong control to ensure that this radioactivity is not released into the atmosphere to avoid atmospheric pollution. A thick concrete shielding and a pressure vessel are provided to prevent the escape of these radiations to atmosphere

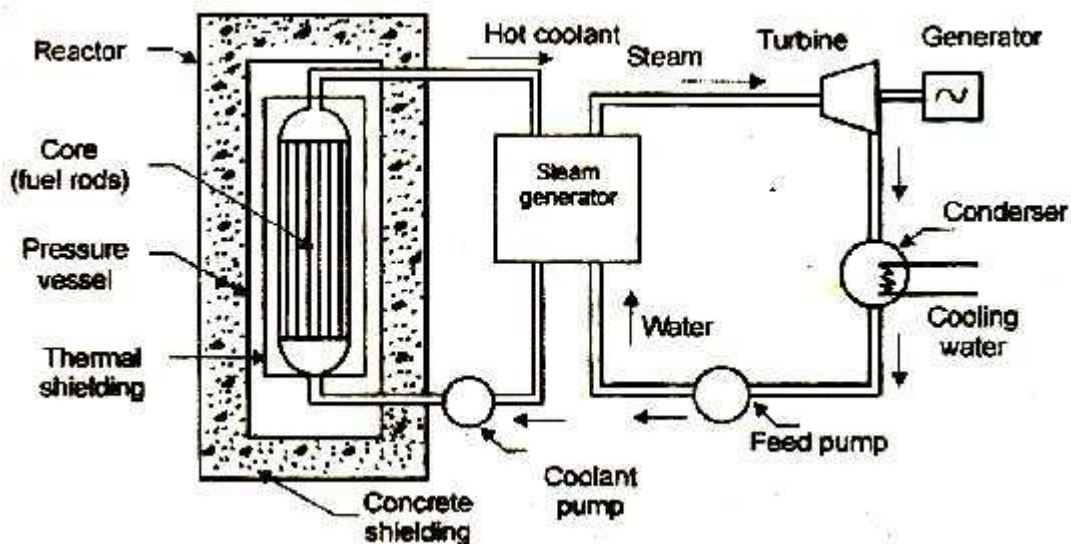

Figure : Nuclear Power Plant (PWR)

vii) Steam generator

The steam generator is fed with feed water which is converted into steam by the heat of the

hot coolant. The purpose of the coolant is to transfer the heat generated in the reactor core and use it for steam generation. Ordinary water or heavy water is a common coolant.

viii) Turbine

The steam produced in the steam generator is passed to the turbine and work is done by the expansion of steam in the turbine.

ix) Coolant pump and Feed pump

The steam from the turbine flows to the condenser where cooling water is circulated. Coolant pump and feed pump are provided to maintain the flow of coolant and feed water respectively.

Advantages of nuclear power plant

1. It can be easily adopted where water and coal resources are not available.
2. The nuclear power plant requires very small quantity of fuel. Hence fuel transportation cost is less.
3. Space requirement is less compared to other power plants of equal capacity.
4. It is not affected by adverse weather conditions.
5. Fuel storage facilities are not needed as in the case of the thermal power plant.
6. Nuclear power plants will converse the fossils fuels (coal, petroleum) for other energy needs.
7. Number of workmen required at nuclear plant is far less than thermal plant.
8. It does not require large quantity of water.

Disadvantages

1. Radioactive wastes, if not disposed of carefully, have adverse effect on the health of workmen and the population surrounding the plant.
2. It is not suitable for varying load condition.
3. It requires well-trained personnel.
4. It requires high initial cost compared to hydro or thermal power plants.

3.5 construction and working principle of Boiling Water Reactor (BWR)

Figure shows a simplified BWR. Light water, which acts as the coolant and moderator, passes through the core where boiling takes place in the upper part of the core. The wet steam then passes through a bank of moisture separators and steam dryers in the upper part of the pressure vessel. The water that is not vaporized to steam is recirculated through the core with the entering feed water using two recirculation pumps coupled to jet pumps (usually 10 to 12 per recirculation pump). The steam leaving the top of the pressure vessel is at saturated conditions of 7.2 MPa and 278°C.

The steam then expands through a turbine coupled to an electrical generator. After condensing to liquid in the condenser, the liquid is returned to the reactors as feedwater. Prior to entering the reactor, the feedwater is preheated in several stages of feedwater heaters. The balance of plant systems (Example: Turbine generator, feedwater heaters) are similar for both PWR and BWRs.

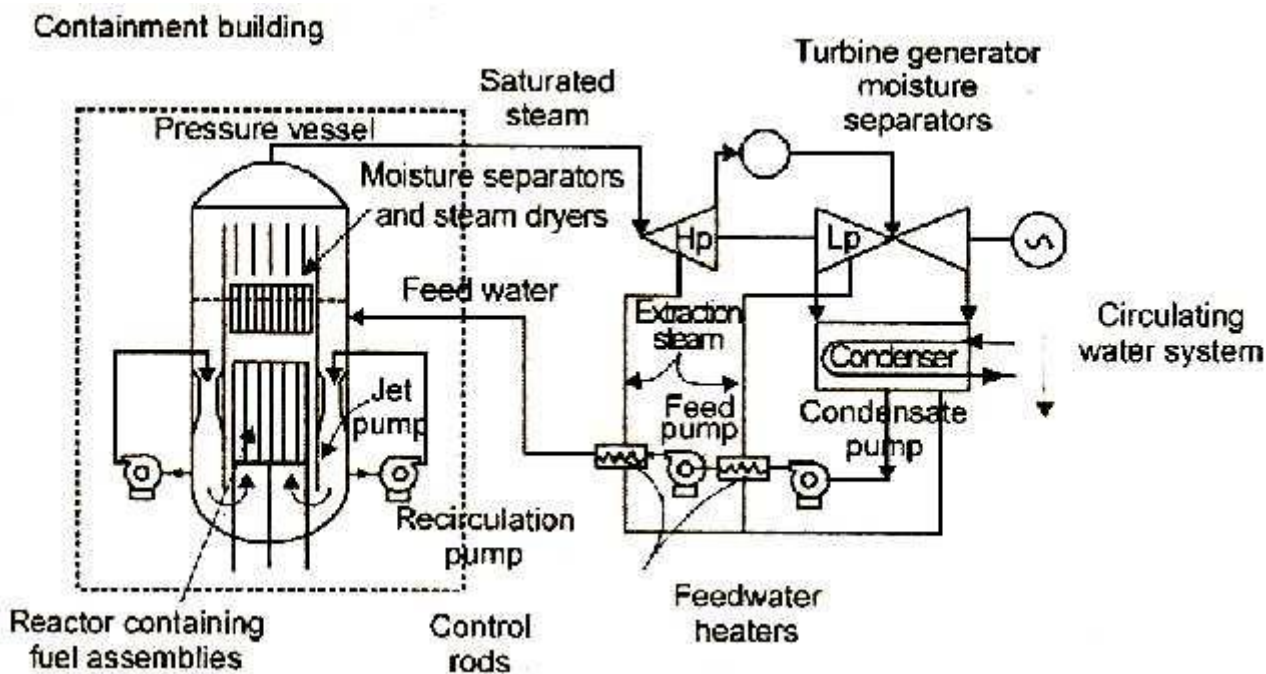

Figure: Schematic for a boiling water reactor.

The BWR reactor core, like that in a PWR, consists of a large number of fuel rods housed in fuel assemblies in a nearly cylindrical arrangement. Each fuel assembly contains an 8×8 or 9×9 square array of 64 or 81 fuel rods (typically two of the fuel rods contain water rather than fuel) surrounded by a square Zircaloy channel box to ensure no coolant crossflow in the core. The fuel rods are similar to the PWR rods, although larger in diameter. Each fuel rod is a zirconium alloy-clad tube containing pellets of slightly enriched uranium dioxide (2% to 5% U-235) stacked end-to-end. The reactor is controlled by control rods housed in a cross-shaped, or cruciform, arrangement called a control element. The control elements enter from the bottom of the reactor and move in spaces between the fuel assemblies.

The BWR reactor core is housed in a pressure vessel that is larger than that of a PWR. A typical BWR pressure vessel, which also houses the reactor core, moisture separators, and steam dryers, has a diameter of 6.4 m, with a height of 22 m. Since a BWR operates at a nominal pressure of 6.9 MPa, its pressure vessel is thinner than that of a PWR.

3.6 construction and working principle of Heavy Water Cooled Reactor (HWR) (or) CANDU Type Reactor (CANDU – Canadium, Deutrium, Uranium).

These reactors are more economically to those nations which do not produce enriched

uranium as the enrichment of uranium is very costly. In this type of reactors, the natural uranium (0.7% U^{235}) is used as fuel and heavy water as moderator.

This type of reactor was first designed and developed in Canada. The first heavy water reactor in Canada using heavy water as coolant and moderator of 200 MW capacity with 29.1% thermal efficiency was established at Douglas (Ontario known as Douglas power station. The arrangement of the different components of CANDU type reactor is shown in figure.

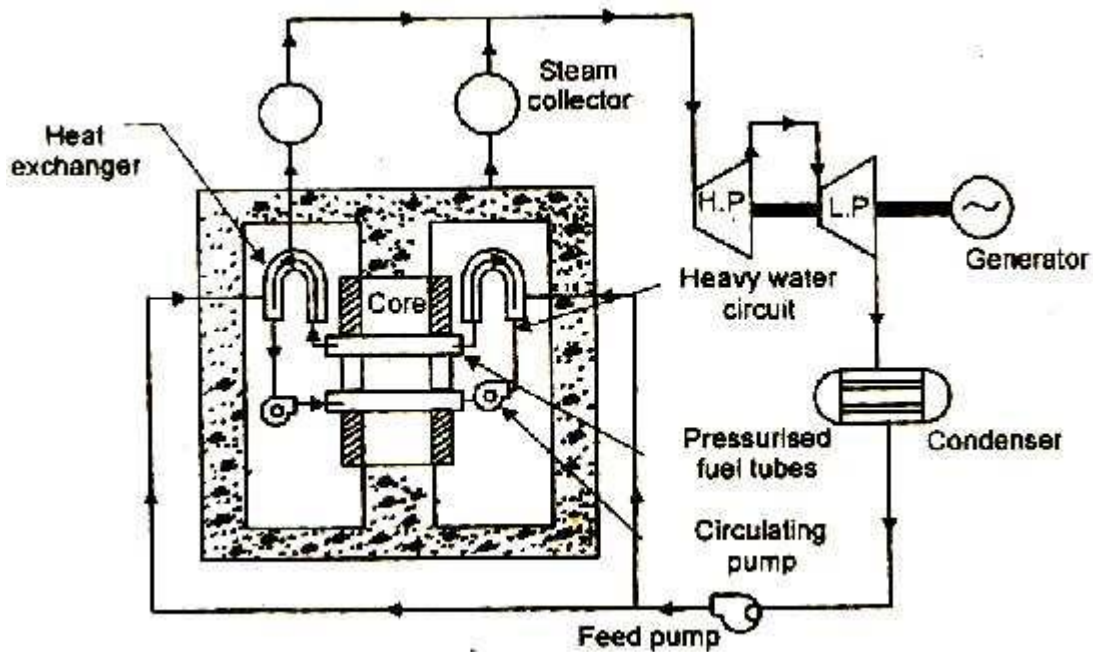

Figure: Douglas-point candu type heavy water moderated and cooled nuclear reactor power plant

The coolant heavy water is passed through the fuel pressure tubes and heat-exchanger. The heavy water is circulated in the primary circuit in the same way as with a PWR and the steam is raised in the secondary circuit transferring the heat in the heat exchanger to the ordinary water.

The control of the reactor is achieved by varying the moderator level in the reactor and, therefore, control rods are not required. For rapid shutdown purpose, the moderator can be dumped through a very large area into a tank provided below the reactor.

3.7 advantages and disadvantages of HWR (or) CANDU type Reactor.

Advantages

1. The major advantage of this reactor is that the fuel need not be enriched.
2. The reactor vessel may be built to withstand low pressure, therefore, the cost of the vessel is less.
3. No control rods are required, therefore, control is much easier than other types.
4. The moderator can be kept at low temperature which increases its effectiveness in slowing-

down neutrons.

5. Heavy water being a very good moderator, this type of reactor has higher multiplication factor and low fuel consumption.
6. A shorter period is required for the site construction compared with PWR and BWR.

Disadvantages

1. The cost of heavy water is extremely high (Rs. 300/kg).
2. The leakage is a major problem as there are two mechanically sealed closures per fuel channel. Canadian designs generally are based on recovering high proportion of heavy water leakages as absolute leak-tightness cannot be assured.
3. Very high standard of design, manufacture inspection and maintenance are required.
4. The power density is considerably low (9.7 kW/litre) compared with PWR and BWR, therefore, the reactor size is extremely large.

Even though CANDU-type reactors look promising in future, light water reactors all over the world proved more efficient than heavy water and in fact only 36 out of 529 power reactors in the world are based on heavy water.

3.8 Sodium Graphite Reactor (SGR)? Sodium Graphite

Reactor (SGR):

The reactor shown in figure uses two liquid metal coolants. Liquid sodium (Na) serves as the primary coolant and an alloy of sodium potassium (NaK) as the secondary coolant.

Sodium melts at 208°C and boils at 885°C. This enables to achieve high outlet coolant temperature in the reactor at moderate pressure nearly atmospheric which can be utilized in producing steam of high temperature, thereby increasing the efficiency of the plant. Steam at temperature as high as 540°C has been obtained by this system. This shows that by using liquid sodium as coolant more electrical power can be generated for a given quantity of the fuel burn up.

Secondly low pressure in the primary and secondary coolant circuits, permits the use of less expensive pressure vessel and pipes etc. Further sodium can transfer its heat very easily. The only disadvantage in this system is that sodium becomes radioactive while passing through the core and reacts chemically with water. So it is not used directly to transfer its heat to the feed water, but a secondary coolant is used. Primary coolant while passing through the tubes of intermediate heat exchanges (I.H.X) transfers its heat to the secondary coolant. The secondary coolant then flows through the tubes of steam generator and passes on its heat to the feed water. Graphite is used as heat transfer media have certain advantages of using liquids used for heat transfer purposes. The various advantages of using liquid metals as heat transfer media are that they have relatively low melting points and combine high densities with low vapour pressure at high temperatures as well as with large thermal conductivities.

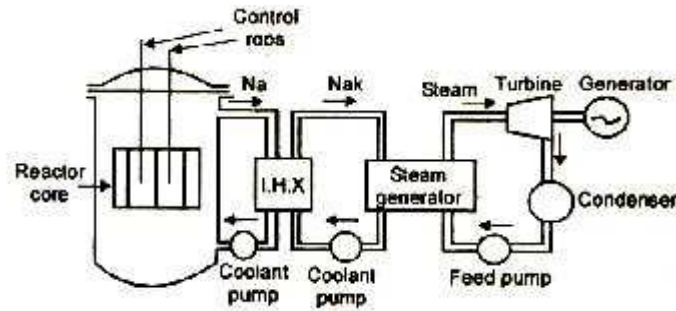

Figure: Sodium graphite reactor

3.9 Fast Breeder Reactor

Figure shows a fast breeder reactor system. In this reactor the core containing U^{235} is surrounded by a blanket (a layer of fertile material placed outside the core) of fertile material U^{238} . In this reactor no moderator is used. The fast moving neutrons liberated due to fission of U^{235} are absorbed by U^{238} which gets converted into fissionable material Pu^{239} which is capable of sustaining chain reaction. Thus this reactor is important because it breeds fissionable material from fertile material U^{238} available in large quantities. Like sodium graphite nuclear reactor this reactor also uses two liquid metal coolant circuits. Liquid sodium is used as primary coolant when circulated through the tubes of intermediate heat exchange transfers its heat to secondary coolant sodium potassium alloy. The secondary coolant while flowing through the tubes of steam generator transfers its heat to feed water.

Fast breeder reactors are better than conventional reactors both from the point of view of safety and thermal efficiency. For India which already is fast advancing towards self reliance in the field of nuclear power technology, the fast breeder reactor becomes inescapable in view of the massive reserves of thorium and the finite limits of its uranium resources. The research and development efforts in the fast breeder reactor technology will have to be stepped up considerably if nuclear power generation is to make any impact on the country's total energy needs in the not too distant future.

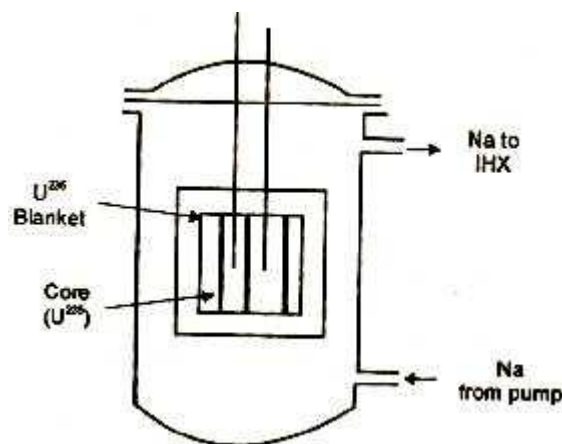

Figure: Fast breeder reactor.

3.10 coolants are used for Fast Breeder Reactors

The commonly used coolants for fast breeder reactors are as follows:

- i) Liquid metal (Na or NaK).
- ii) Helium (He)
- iii) carbon dioxide.

Sodium has the following advantages:

- i) It has very low absorption cross-sectional area.
- ii) It possesses good heat transfer properties at high temperature and low pressure.
- iii) It does not react on any of the structural materials used in primary circuits.

3.11 safety Measures carried out in Nuclear Power Plant Safety for nuclear power plants:

Nuclear power plants should be located far away from the populated area to avoid the radioactive hazard. A nuclear reactor produces α and β particles, neutrons and γ - quanta which can disturb the normal functioning of living organisms. Nuclear power plants involve radiation leaks, health hazard to workers and community, and negative effect on surrounding forests.

At nuclear power plants there are three main sources of radioactive contamination of air.

1. Fission of nuclei of nuclear fuels.
2. The second source is due to the effect of neutron fluxes on the heat carrier in the primary cooling system and on the ambient air.
3. Third source of air contamination is damage of shells of fuel elements.

This calls for special safety measures for a nuclear power plant. Some of the safety measures are as follows.

1. Nuclear power plant should be located away from human habitation.
2. Quality of construction should be of required standards.
3. Waste water from nuclear power plant should be purified.

The water purification plants must have efficiency of water purification and satisfy rigid requirements as regards the volume of radioactive wastes disposed to burial.

4. An atomic power plant should have an extensive ventilation system. The main purpose of this ventilation system is to maintain the concentration of all radioactive impurities in the air below the permissible concentrations.
5. An exclusion zone of 1.6 km radius around the plant should be provided where no public habitation is permitted.
6. The safety system of the plant should be such as to enable safe shut down of the reactor whenever required.

3.12 wastes are disposed from nuclear power plant Waste Disposal:

Waste disposal problem is common in every industry. Wastes from atomic energy installations are radioactive, create radioactive hazard and require strong control to ensure that radioactivity is not released into the atmosphere to avoid atmospheric pollution.

The wastes produced in a nuclear power plant may be in the form of liquid, gas or solid and each is treated in a different manner:

UNIT – IV

PART – A

1. Define heat engine?

Any type of engine or machine which derives heat energy from the combustion of fuel or any other source and converts this energy into mechanical work is termed as a heat engine.

2. What are the essential component of diesel power plants?

Essential components of a diesel power plant are:

- (i) Engine
- (ii) Air intake system
- (iii) Exhaust system
- (iv) Fuel system
- (v) Cooling system
- (vi) Lubrication system
- (vii) Engine starting system
- (viii) Governing system.

3. What are the injection system's are used in diesel power plants?

Commonly used fuel injection system in a diesel power station:

- (i) Common-rail injection system
- (ii) Individual pump injection system
- (iii) Distribution system.

4. List the various Liquid Cooling System?

In liquid cooling following methods are used for circulating the water around the cylinder and cylinder head:

- (i) Thermo-system cooling
- (ii) Forced or pump cooling

- (iii) Cooling with thermostatic regulator
- (iv) Pressurized cooling
- (v) Evaporative cooling.

5. What are the various Lubricating system's are used in I.C Engines?

Various Lubrications systems use for I.C. engines are:

- (i) Wet sump lubrication system
- (ii) Dry sump lubrication system
- (iii) Mist lubrication system.

6. Mention three starting systems for Large and Medium size engines?

The following three are the commonly used starting systems in large and medium size engines:

- (i) Starting by an auxiliary engine
- (ii) Use of electric motors of self starters
- (iii) compressed air system.

7. What is the purpose of super charging?

The purpose of supercharging is to raise the volumetric efficiency above that value which can be obtained by normal aspiration.

8. What are the classifications of Heat Engine?

Heat engines are classified into two types:

- 1) External combustion engines,
- 2) Internal combustion engines.

9. Define connecting rod?

It connects the piston and the crankshaft, thereby transmitting the force exerted on the piston to the crankshaft.

10. Define crankshaft?

It converts the reciprocating motion of the piston into the rotary motion of the output shaft. It is enclosed in the crankcase.

11. Define Flywheel?

It is a heavy wheel mounted on the crankshaft. It stores the excess energy delivered by the engine during power stroke and supplies the energy needed during other strokes. Thus it keeps the fluctuations in the crankshaft speed within desired limits.

12. What are the 2 – cooling Medium in cooling system?

The cooling medium used in the cooling system can be air or water. There are two types of cooling systems:

- 1) Liquid or indirect cooling system,
- 2) Air or direct cooling system.

13. Write the three types of liquid cooling systems?

This system can be classified under three types:

- i) Natural circulation type or thermo syphon system,
- ii) forced circulation system,
- iii) Thermostatic cooling system.

14. Write the Disadvantages of over cooling of the Engine?

- 1) Engine starting is difficult,
- 2) Over-cooling reduces the overall efficiency of the system,
- 3) At low temperatures, corrosion assumes considerable magnitude that it may reduce the life of various components.

15. Write the advantages of Air cooling?

1. It occupies less space,
2. Air cooled engine are lighter than water-cooled engines. Hence used in two wheelers, agricultural sprayers, etc.
3. Engine warms up faster than water cooled engines,
4. Practically, there is no need for maintenance.

16. Write the advantages of Water cooling?

- 1) Cooling is more efficient,
- 2) Uniformity in cooling,
- 3) Engines cooled by water can be placed anywhere in the vehicle.

17. Write the function of Lubrication?

- a. To reduce the wear and tear between the moving parts and thereby increasing the life of the engine.
- b. The lubricating oil acts as a seal, i.e., it prevents the high pressure gases in the combustion chamber from entering the crankcase
- c. To cool the surfaces.

18. What are the classifications of Lubrication system?

Classification of Lubrication System: Some of the lubricating systems used for IC engines are:

- i) Wet sump lubricating system,
- ii) Mist lubricating system.

Wet sump lubricating system can be further classified as,

- i) Splash type lubricating system,
- ii) Pressure feed lubricating system.

19. What are the components of fuel injector?

The fuel injector or atomizer consists of:

- 1) Needle valve,
- 2) Compression spring,
- 3) Nozzle,
- 4) Injector body.

20. What are the duties of Air intake systems?

The duties of the air intake systems are as follows:

- i) To clean the air intake supply,
- ii) To silence the intake air,
- iii) To supply air for super charging.

21. Define – open cycle gas turbine?

In the open cycle gas turbine, air is drawn into the compressor from atmosphere and is compressed. The compressed air is heated by directly burning the fuel in the air at constant pressure in the combustion chamber. Then the high pressure hot gases expand in the turbine and mechanical power is developed.

22. Define – closed cycle gas turbine?

In this, the compressed air from the compressor is heated in a heat exchange (air heater) by some external source of heat (coal or oil) at constant pressure. Then the high pressure hot gases expand passing through the turbine and mechanical power is developed. The exhaust gas is then cooled to its original temperature in a cooler before passing into the compressor again.

23. Write the few fuels for Gas turbine and why these fuels are use for gas turbine?

Natural gas, last furnace gas, produce gas, coal gas and solid fuels distillate oils and residual oils paraffins used in gas turbine and methane, ethane, propane, octane. Important properties to be considered while selecting the fuel for gas turbine are as follows: 1) Volatility 2) Combustion products, 3) Energy contents, 4) Lubricating properties, 5) Availability.

24. Write the major field of application of gas turbines?

The major fields of application of gas turbines are:

- i) Aviation
- ii) Power generation
- iii) Oil and gas industry
- iv) Marine propulsion.

25. Define Gas turbine plant and write the working medium of this gas turbine?

A gas turbine plant may be defined as one “in which the principal prime-mover is of the turbine type and the working medium is a permanent gas”.

26. What are the components of gas turbine plant?

A simple gas turbine plant consists of the following:

- i) Turbine
- ii) Compressor
- iii) Combustor
- iv) Auxiliaries.

A modified plant may have in addition and intercooler, a regenerator, a reheater etc.

27. What are the methods to improving the thermal efficiency in open cycle gas turbine plant?

Methods for improvement of thermal efficiency of open cycle gas turbine plant are :

- i) Inter cooling
- ii) Reheating
- iii) Regeneration

28. What is the main difference between free piston engine plants and conventional gas turbine plant?

Free-piston engine plants are the conventional gas turbine plants with the difference that the air compressor and combustion chamber are replaced by a free piston engine.

4.1 construction and working principle of Open cycle gas turbine power plant

In the open cycle gas turbine, air is drawn into the compressor from atmosphere and is compressed. The compressed air is heated by directly burning the fuel in the air at constant pressure in the combustion chamber. Then the high pressure hot gases expand in the turbine and mechanical power is developed.

Part of the power developed by the turbine (about 66%) is used for driving the compressor. The remaining is available as useful output. The working fluid, air and fuel, must be replaced continuously as they are exhausted into the atmosphere. Thus the entire flow comes from the atmosphere and is returned to the atmosphere.

4.2 construction and working principle of closed cycle gas turbine power plant

In this, the compressed air from the compressor is heated in a heat exchanger (air heater) by some external source of heat (coal or oil) at constant pressure. Then the high pressure hot gases expand passing through the turbine and mechanical power is developed. The exhaust gas is then cooled to its original temperature in a cooler before passing into the compressor again.

The main difference between the open and closed cycles is that the working fluid is continuously replaced in open cycle whereas it is used again and again in a closed cycle. The open cycle plant is much lighter than the closed cycle. Hence it is widely used.

4.3 Gas turbine Fuels

Various fuels used by gas turbine power plants are liquid fuels and gaseous fuels such as natural gas, blast furnace gas, producer gas coal gas and solid fuels such as pulverized coal. Care should be taken that the oil fuel should not contain moisture and suspended impurities.

The different types of oils used may distilled oils and residual oils. The various paraffins used in gas turbine are methane, ethane, propane, octane (gasoline) and dodecane (kerosene oil). Out of these gasoline and kerosene or blend of the two are commonly used.

Qualities of Fuel

Some of the important properties to be considered while selecting the fuel for gas turbine are as follows:

1. Volatility

This property has a major effect on starting and combustion efficiency of the engine particularly at low temperature and other adverse conditions. The volatility of the fuel should be such that it is conducive to a quick and successful restart blowout of flame. Highly volatile fuels are also not desirable as they have the following disadvantages:

- i) They are more susceptible to fire (although they have less tendency to explode).
- ii) They are conducive to vapour lock to excessive loss of fuel during flight because of evaporation of certain lighter hydrocarbons. Therefore, in case of aircraft gas turbines in which the quantity of fuel used is sufficiently high, the fuel wastage will also be more if the fuel is highly volatile.

2. Combustion products

The products of combustion should not be in the form of solids because they tend to deposit on the combustion chambers, turbine blades and vanes and cause a loss in efficiency.

3. Energy contents

Fuel should have greater heating value so that fuel consumption may be less.

4. Lubricating properties

The fuel should provide a certain amount of lubrication of friction surfaces of fuel pumps.

5. Availability

The fuel selected should be available in large quantities so that it is cheaper.

Comparison of kerosene oil and gasoline

Kerosene is quite commonly by used in aircraft gas turbines. It is not as volatile as gasoline and, therefore, there is less possibility of vapour lock and fuel loss. But its combustion efficiency is low compared to gasoline. The lubrication properties of gasoline are poorer. About 5 to 20% of a barrel of crude may be refined kerosene whereas 40 to 50% of a barrel of crude oil may be refined into gasoline which shows that gasoline can be available in large quantities.

4.7 gas turbine

1. **Air ratio**
2. **Pressure ration**
3. **Work Ratio**
4. **Compressor efficiency**
5. **Engine efficiency**
6. **Machine efficiency**
7. **Combustion efficiency**
8. **Thermal efficiency**

Some of the important terms used to measure performance of a gas turbine are defined as follows:

1. **Pressure ratio.** It is the ratio of cycle's highest to its lowest pressure, usually highest pressure-compressor discharges to the lowest-pressure-compressor inlet pressures.
2. **Work ratio.** It is the ratio of network output to the total work developed in the turbine or turbines.
3. **Air ratio.** Kg of air entering the compressor inlet per unit of cycle net output, for example, kg/kWh.
4. **Compression efficiency** It is the ratio of work needed for ideal air compression through a given pressure range to work actually used by the compressor.
5. **Engine efficiency.** It is the ratio of work actually developed by the turbine expanding hot power gas through a given pressure range to that would be yielded for ideal expansion conditions.

6. **Machine efficiency.** It is the collective term meaning both engine efficiency and compressor efficiency of turbine and compressor efficiency of turbine and compressor, respectively.
7. **Combustion efficiency.** It is the ratio of heat actually released by 1 kg of fuel to heat that would be released by complete perfect combustion.
8. **Thermal efficiency.** It is the percentage of total energy input appearing as net work output of the cycle.

4.8 gas turbine cycle with reheat. Reheat gas

C : Compressor

CC: Combustion chamber

G : Generator

f : Fuel

HPT: High Pressure turbine

LPT: Low pressure turbine

RCC: Reheat combustion chamber

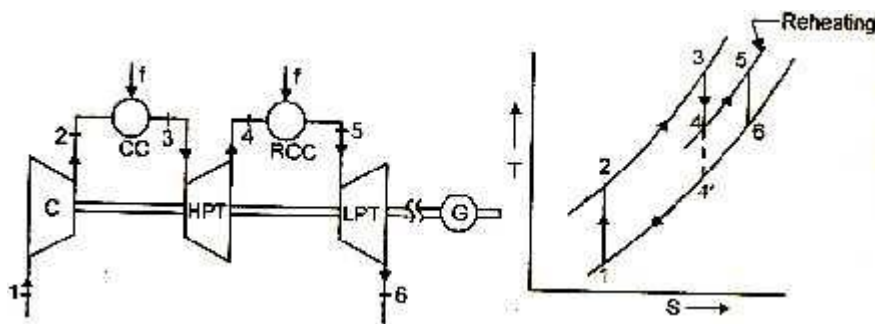

Figure: Reheat gas turbine cycle.

Reheat gas turbine cycle arrangement is shown in figure. In order to maximize the work available from the simple gas turbine cycle one of the option is to increase enthalpy of fluid entering gas turbine and extend its expansion upto the lowest possible enthalpy value. This can also be said in terms of pressure and temperature values i.e., inject fluid at high pressure and temperature into gas turbine and expand upto lowest possible pressure value. Upper limit at inlet to turbine is limited by metallurgical limits while lower pressure is limited to near atmospheric pressure in case of open cycle. For further increasing in net work output the positive work may be increased by using multistage expansion with reheating in between. In multistage expansion is divided into parts and after part expansion working fluid may be reheated for getting larger positive work in left out expansion. For reheating another combustion chamber may be used.

Here in the arrangement shown ambient air enters compressor and compressed air at high pressure leaves at 2. Compressed air is injected into combustion chamber for increasing its temperature upto desired turbine inlet temperature at state 3. High pressure and high temperature fluid enters high pressure turbine (HPT) for first phase of expansion and expanded gases leaving at 4 are sent to reheat combustion chamber (reheater) for being further heated. Thus reheating is a kind of energizing the working fluid. Assuming perfect reheating (in which temperature after

reheat is same as temperature attained in first combustion chamber), the fluid leaves at state 5 and enters low pressure turbine (LPT) for remaining expansion upto desired pressure value. Generally temperature after reheating at state 5, is less than temperature at state 3. In the absence of reheating the expansion process within similar pressure limits goes upto state 4'. Thus reheating offers an obvious advantage of work output increase since constant pressure lines T-S diagram diverge slightly with increasing entropy, the total work of the two stage turbine is greater that that of single expansion from state 3 to state 4', i.e., $(T_3 - T_4) + (T_5 - T_6) > (T_3 - T_4')$.

Here it may be noted that the heat addition also increases because of additional heat supplied for reheating. Therefore, despite the increase in network due to reheating the cycle thermal efficiency would not necessarily increases. Let us now carry out air standard cycle analysis.

$$\begin{aligned} \text{Network output in reheat cycle, } W_{\text{net, reheat}} &= W_{\text{HPT}} + W_{\text{LPT}} - W_{\text{C}} \\ W_{\text{HPT}} &= m (h_3 - h_4), W_{\text{LPT}} = m(h_5 - h_6), W_{\text{C}} = m(h_2 - h_1) \\ W_{\text{net, reheat}} &= m \{(h_3 - h_4) + (h_5 - h_6) - (h_2 - h_1)\} \\ W_{\text{net, reheat}} &= m c_p \{(T_3 - T_4) + (T_5 - T_6) - (T_2 - T_1)\} \end{aligned}$$

Assuming, $T_3 = T_5$

$$\begin{aligned} W_{\text{net, reheat}} &= m c_p \{(2T_3 - T_4) - T_6 - (T_2 - T_1)\} \\ Q_{\text{in}} &= m c_p \{(T_3 - T_2) + (T_5 - T_4)\} \\ \eta_{\text{reheat}} &= \frac{W_{\text{net, reheat}}}{Q_{\text{in}}} \end{aligned}$$

4.8 working of gas turbine cycle with regenerator.

In earlier discussion it is seen that for the maximization of specific work output the gas turbine exhaust temperature should be equal to compressor exhaust temperature. The turbine exhaust temperature is normally much above the ambient temperature. Thus their exist potential for tapping the heat energy getting lost to surroundings with exhaust gases. Here it is devised to use this potential by means of a heat exchanger called regenerator, which shall preheat the air leaving compressor before entering the combustion chamber, thereby reducing the amount of fuel to be burnt inside combustion chamber (combustor).

Regenerative air standard gas turbine cycles shown ahead in figure (a) has a regenerator (counter flow heat exchanger) through which the hot turbine exhaust gas and comparatively cooler air coming from compressor flow in opposite directions. Under ideal conditions, no frictional pressure drop occurs in either fluid stream while turbine exhaust gas gets cooled from 4 to 4' while compressed air is heated from 2 to 2'. Assuming regenerator effectiveness as 100% the temperature rise from 2 - 2' and drop from 4 to 4' is shown on T-S diagram.

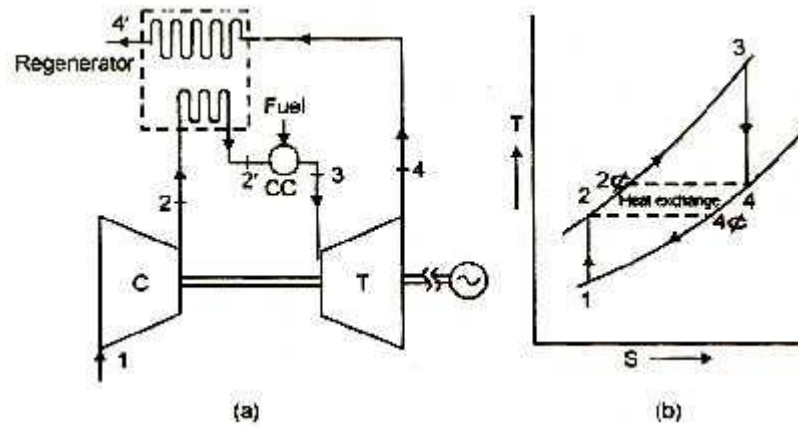

Figure: Regenerative air standard gas turbine cycle.

Regenerator effectiveness, $\varepsilon = \frac{h_{2'} - h_2}{h_4 - h_2}$, where 'h' refers to specific enthalpy values.

Thus thermodynamically the amount of heat now added shall be

$$Q_{\text{add, regen}} = m(h_3 - h_{2'})$$

Whereas without regenerator the heat added; $Q_{\text{add}} = m(h_3 - h_2)$

Here it is obvious that, $Q_{\text{add, regen}} < Q_{\text{add}}$

This shows an obvious improvement in cycle thermal efficiency as every thing else remains same. Network produced per unit mass flow is not altered by the use of regenerator.

Air standard cycle thermal efficiency,

$$= \frac{h_3 - h_4}{h_3 - h_2} \eta_{\text{regen}} - \frac{h_2 - h_1}{h_3 - h_2}$$

$$\eta_{\text{regen}} = \frac{C_p(T_3 - T_4)}{C_p(T_3 - T_2)}$$

4.9 working of gas turbine cycle with inter cooling.

Net work output from gas turbine cycle can also be increased by reducing negative work i.e., compressor work. Multistaging of compression process with intercooling in between is one of the approaches for reducing compression work. It is based on the fact that for a fixed compression ratio is higher is the inlet temperature higher shall be compression work requirement and vice-versa. Schematic for inter cooled gas turbine cycle is give in figure.

Thermodynamic processes involved in multistage inter cooled compression are shown in figure. First stage compression occurs in low pressure compressor (LPC) and compressed air

leaving LPC at '2' is sent to intercooler where temperature of compressed air is lowered down to state 3 at constant pressure. In case of perfect intercooling the temperature after intercooling is brought down to ambient temperature i.e., temperature at 3 and 1 are same. Intercooler is a kind of heat exchanger where heat is picked up from high temperature compressed air. The amount of compression work saved due to intercooling is obvious from p-V diagram and shown by area 2342'. Area 2342' gives the amount of work saved due to intercooling between compression.

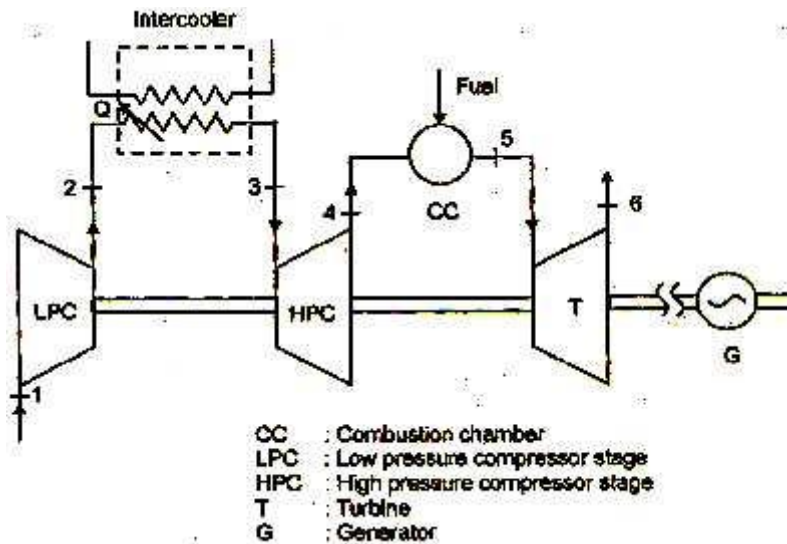

Figure: Gas turbine cycle with intercooling

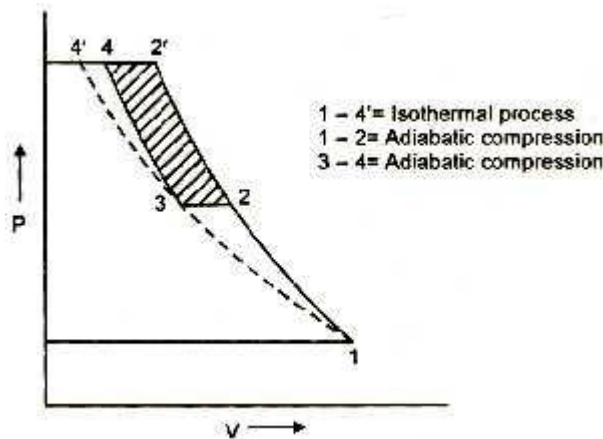

Figure : Intercooled compression

Some large compressors have several stages of compression with intercooling between stages. Use of multistage compression with intercooling in a gas turbine power plant increases the network produced because of reduction in compressor work. Inter cooled compression results in reduced temperature at the end of final compression. T-S diagram for gas turbine cycle with intercooling shows that in the absence of intercooling within same pressure limits the state at the end of compression would be 2' while with perfect intercooling this state is at 4 i.e., $T_2' > T_4$. The reduced temperature at compressor exits leads to additional heat requirement in combustion

chamber i.e., more amount of fuel is to be burnt for attaining certain inlet temperature as compared to simple cycle without intercooling.

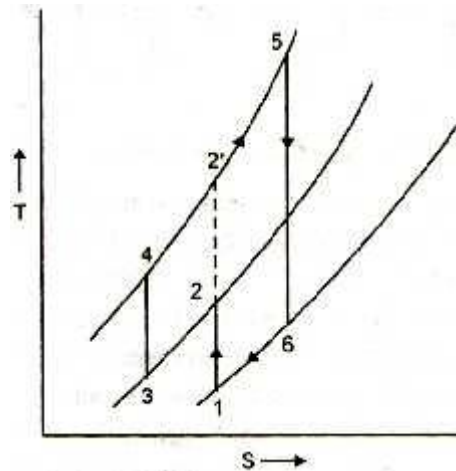

Figure: T-S diagram for gas turbine cycle with intercooling

Thus intercooled cycle thermal efficiency may not increase with intercooling because of simultaneous increase in heat addition requirement. The lower temperature at compressor exit enhances the potential for regeneration so when intercooling is used in conjunction with regeneration an appreciable increase in thermal efficiency can result.

Net work output in gas turbine cycle with intercooling;

$$W_{\text{net, intercool}} = m\{(h_5 - h_6) - (h_4 - h_3) - (h_2 - h_1)\}$$

$$W_{\text{net, intercool}} = m c_p \{(T_5 - T_6) - (T_4 - T_3) - (T_2 - T_1)\}$$

Cycle thermal efficiency;

$$\eta_{\text{intercool}} = \frac{\{(h_5 - h_6) - (h_4 - h_3) - (h_2 - T_1)\}}{\{(h_5 - h_4) - (h_3 - h_2)\}}$$

4.10 Advantages and disadvantages of Gas turbine power plant

Advantages of Gas Turbine Power Plant

1. They are small in size, weigh less and have low initial cost per unit output.
2. They are easy to install within short periods.
3. They are quick-starting and smooth running.
4. They offer flexibility by supplying electricity for power generation as well as by supplying compressed air for process needs.
5. They are capable of using a range of liquid and gaseous fuels including synthetic fuels.

6. They are subjected (put) to fewer environmental restrictions than other prime movers.
7. Water consumption is less compared to steam power plant.

Disadvantages

1. An electric motor or an I.C. engine is necessary for starting the plant. The starting motor must bring the compressor well towards the operating speed. So, starting is not simple as in the case of other power plants.
2. Gas turbine plants have less vibrations when compared with reciprocating engines of the same speed. However the high frequency noise from the compressor is objectionable.
3. High temperatures impose severe restriction on the servicing conditions of the plant.
4. Overall efficiency is low since two-thirds of the total power output is used for driving the compressor.
5. The blades of the turbine require special cooling methods due to the severity of operating temperatures and pressures. In practice, the temperatures at the entry of the turbine are as high as 1100°C - 1260°C. Hence they should be made of special metals and alloys.
6. They are incompatible with solid fuels.

4.11 DIESEL ENGINE POWER PLANT SYSTEMS

The diesel engine power plant consists of the following auxiliary systems:

Fuel Supply System

It consists of fuel tank for the storage of fuel, fuel filters and pumps to transfer and inject the fuel. The fuel oil may be supplied at the plant site by trucks, rail, road, tank, cars, etc.

Air Intake and Exhaust System

It consists of pipe for the supply of air and exhaust of the gases. Filters are provided to remove dust etc. from the incoming air. In the exhaust system silencer is provided to reduce the noise.

Filters may be of dry type (made up of cloth, felt, glass, wool etc.) or oil bath type. In oil bath type of filters the air is swept over or through a bath of oil in order that the particles of dust get coated. The duties of the air intake systems are as follows:

- i) To clean the air intake supply.
- ii) To silence the intake air.
- iii) To supply air for super charging.

The intake system must cause a minimum pressure loss to avoid reducing engine capacity and raising the specific fuel consumption. Filters must be cleaned periodically to prevent pressure losses from clogging. Silencers must be used on some systems to reduce high velocity air noises.

3. Cooling Systems

This system provides a proper amount of water circulation all around the engines to keep the temperature at reasonable level. Pumps are used to discharge the water inside and the hot water leaving the jacket is cooled in cooling ponds or other devices and is recirculated again.

4. Lubrication System

Lubrication is essential to reduce friction and wear of the rubbing parts. It includes lubricating oil tank, pumps, filters and lubricating oil cooler.

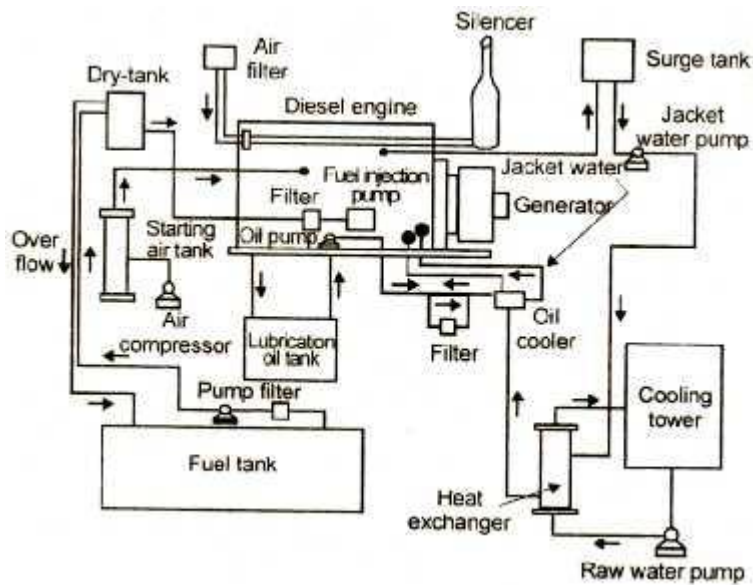

Figure : Schematic representation of a diesel engine power plant.

5. Starting System

For the initial starting of engine the various devices used are compressed air, battery, electric motor or self-starter. The auxiliary equipment of diesel engine power plant.

UNIT – V

PART – A

1. Define Tide?

The periodic rise and fall of the water level of sea which are carried by the action of sun and moon on water of the earth is called the tide.

2. In which system the power is Intermittently generated?

In a single basin arrangement power can be generated only intermittently.

3. What are the consistencies 'Solar farm' and 'Solar tower'?

The solar farm consists of a whole field covered with parabolic trough concentrators and a 'solar tower' consists of a central receiver on a tower and a whole field of tracking.

4. Define Seebeck effect?

"If two dissimilar materials are joined to form a loop and the two junctions maintained at different temperatures, an e.m.f. will be set up around the loop". This is called Seebeck effect.

5. What is working principle of thermionic?

A thermionic converter works because of the phenomenon of 'thermionic emission'.

6. What is Photo voltaic effect?

'Photovoltaic effect' is defined as the generation of an electromotive force as a result of absorption of ionizing radiation.

7. Write a short notes on MHD – generator?

'MHD generator' is a device which converts heat energy of a fuel directly into electrical energy without a conventional electric generator.

8. Write a short notes on Fuel cell?

A 'fuel cell' is an electrochemical device in which the chemical energy of a conventional fuel is converted directly and efficiently into low voltage, direct current electrical energy.

9. List the non – conventional energy sources?

The various non-conventional energy sources are as follows:

- Solar energy
- Wind energy
- Energy from biomass and biogas
- Ocean thermal energy conversion
- Tidal energy
- Geothermal energy
- Hydrogen energy
- Fuel cells
- Magneto-hydrodynamics generator
- Thermionic converter
- Thermo-electric power.

10. Write the advantages of non – conventional Energy sources?

Advantages of non-conventional energy sources:

The leading advantages of non-conventional energy sources are:

1. They do not pollute the atmosphere
2. They are available in large quantities.
3. They are well suited for decentralized use.

11. Write the characteristic's of wind energy?

1. Wind-power systems do not pollute the atmosphere.
2. Fuel provision and transport are not required in wind-power systems.
3. Wind energy is a renewable source of energy.
4. Wind energy when produced on small scale is cheaper, but competitive with conventional power generating systems when produced on a large scale.

Wind energy entails following short comings/problems:

1. It is fluctuating in nature.
2. Due to its irregularity it needs storage devices.
3. Wind power generating systems produce ample noise.

12. What are the types of wind mills?

1. Multiple blade type
2. Savonius type
3. Darrieus type

13. Write the types of wind machines?

1. Horizontal axis wind machines
2. Vertical axis wind machines

14. Write the classification of Tidal power plants?

1. Single Basin arrangement.
2. Double Basin arrangement.

15. What are the advantages and limitation of Tidal power generation?

Advantages:

1. Tidal power is completely independent of the precipitation (rain) and its uncertainty besides being inexhaustible.
2. Large area of valuable land is not required.

3. When a tidal power plant works in combination with thermal or hydro-electric system peak power demand can be effectively met with.
4. Tidal power generation is free from pollution.

Limitations:

1. Due to variation in tidal range the output is not uniform.
2. Since the turbines have to work on a wide range of head variation (due to variable tidal range) the plant efficiency is affected.
3. There is a fear of machinery being corroded due to corrosive sea water.
4. It is difficult to carry out construction in sea.
5. As compared to other sources of energy, the tidal power plant is costly.
6. Sedimentation and silteration of basins are the problems associated with tidal power plants.
7. The power transmission cost is high because the tidal power plants are located away from load centres.

The first commercial tidal power station in the World was constructed in France in 1965 across the mouth of La Rance Estuary. It has a high capacity of 240 MW. The average tidal range at La Rance is 8.4 m and the dam built across the estuary encloses an area of 22 km².

16. Write the advantages of MHD systems?

1. More reliable since there are no moving parts.
2. In MHD system the efficiency can be about 50% (still higher expected) as compared to less than 40% for most efficient steam plants.
3. Power produced is free of pollution.
4. As soon as it is started it can reach the full power level.
5. The size of plant is considerably smaller than conventional fossil fuel plants.
6. Less overall operational cost.
7. The capital cost of MHD plants is comparable to those of conventional steam plants.
8. Better utilization of fuel.
9. Suitable for peak power generation and emergency service.

17. Write the advantages and disadvantages of fuel cell?

Advantages

1. Conversion efficiencies are very high.
2. Require little attention and less maintenance.
3. Can be installed near the use point, thus reducing electrical transmission requirements and accompanying losses.
4. Fuel cell does not make any noise.
5. A little time is needed to go into operation.
6. Space requirement considerably less in comparison to conventional power plants.

Disadvantages

1. High initial cost
2. Low service life.

18. Write the application of fuel cell?

The application of fuel cell relate to:

1. Domestic use.
2. Automotive vehicles
3. Central power stations.
4. Special applications.

19. Write the advantages of OTEC?

1. Ocean is an infinite heat reservoir which receives solar incidence throughout the year.
2. Energy is freely available

20. Write the disadvantages of OTEC?

1. Efficiency is very low, about 2.5%, as compared to 30 - 40% efficiency for conventional power plants.
2. Capital cost is very high

21. Define – Tidal power plant?

The tidal power plants are generally classified on the basis of the number of basins used for power generations. They are further subdivided as one-way or two-way system as per the cycle of operation for power generation.

22. Define – Renewable sources of energy?

Renewable sources of energy are continuously produced in nature, and they will not get exhausted eventually in future.

23. Define – Non-renewable source of energy?

Non-renewable sources of energy will get exhausted eventually in future. Example: Energy from fossil fuels.

24. Mention some conventional sources?

Fossil fuels, hydel energy and nuclear energy.

25. Mention some Non-conventional sources?

Solar energy, wind energy, tidal energy, ocean thermal energy, geothermal energy and biomass.

26. What are the 3 – mayor energy sources?

The energy sources available can also be classified into three major types based on the yield of net energy. They are:

- i) Primary energy sources,
- ii) Secondary energy sources,
- iii) Supplementary energy sources.

27. What are the five general categories of geothermal sources?

The following five general categories of geothermal sources have been identified.

1. Hydrothermal convective systems
 - Vapour – dominated or dry steam fields.
 - Liquid – dominated system or wet steam fields.
 - Hot – water fields.
2. Geopressure resources.
3. Petro-thermal or hot dry rocks (HDR)
4. Magma resources
5. Valcanoes.

28. Write the application of geothermal energy?

The following are the three main applications of the steam and hot water from the wet geothermal reservoirs:

1. Generation of electric power.
2. Space heating for buildings.
3. Industrial process heat.

The major benefit of geothermal energy is its varied application and versatility.

29. What are the Advantages and disadvantages of Geothermal Energy over other Energy forms?

Advantages of geothermal process:

1. Geothermal energy is cheaper.
2. It is versatile in its use.
3. It is the least polluting as compared to other conventional energy sources.
4. It is amenable for multiple uses from a single resources

- 5. Geothermal power plants have the highest annual load factors of 85 percent to 90 per cent compared to 45 per cent to 50 per cent for fossil fuel plants.
- 6. It delivers greater amount of net energy from its system as compared to other alternative or conventional systems.
- 7. Geothermal energy from the earth's interior is almost as inexhaustible as solar or wind energy, so long as its sources are actively sought and economically tapped.

Disadvantages:

- 1. Low overall power production efficiency (about 15% as compared to 35% to 40% for fossil fuel plants).
- 2. Drilling operation is noisy.
- 3. Large areas are needed for exploitation of geo-thermal energy.
- 4. The withdrawal of large amounts of steam or water from a hydro-thermal reservoir may result in surface subsidence or settlement.

5.1 construction and working principle of Solar power plant

Figure shows a solar power plant with a low temperature solar engine using heated water from flat plate solar collector and butane as the working fluid. This was developed to lift water for irrigation purposes.

1. Solar collectors
a) Flat plate collector

Figure: Flat plate collector figure: Cylindrical parabolic concentrator collector

In a flat plate collector (figure), the radiation energy of the sun falls on a flat surface coated with black paint having high absorbing capacity. It is placed facing the general direction of the sun. The materials used for the plate may be copper, steel aluminium. The thickness of the plate is 1 to 2 mm. Tubing of copper is provided in thermal contact with the plate.

Heat is transferred from the absorbed plate to water which is circulated in the copper tubes through the flat plate collection.

Thermal insulation is provided behind the absorber plate to prevent heat losses from the rear surface. Insulating material is generally fibre glass or mineral wool. The front cover is made up of glass and it is transparent to the incoming solar radiations.

b) Cylindrical parabolic concentrator collector

Concentrator collectors (figure) are of reflecting type utilizing mirrors. The reflecting surface may be parabolic mirror. The solar energy falling on the collector surface is reflected and focused along a line where the absorber tube is located. As large quantity of energy falling on the collector surface is collected over a small surface, the temperature of the absorber fluid is very much higher than in flat plate collector.

While flat place collectors may be used to heat water upto 80°C (low temperature), the concentrating type of collectors are designed to heat water to medium and high temperature ranges.

c) Butane boiler

The water heated in flat plate solar collector to 80°C is used for boiling butane at high pressure in the butane boiler. Boiling point of butane is about 50°C.

d) Turbine

The butane vapour generated at high pressure in the boiler is used to run the vapour turbine which drives the electrical generator.

The vapour coming out of the turbine at low pressure is condensed in a condenser using water. The condensed liquid butane is fed back to the butane boiler using feed pump.

Tower concept for power generation

The tower concept consists of an array of plane mirrors or heliostats which are individually controlled to reflect radiations from the sun into a boiler mounted on a 500 metres high tower. Steam is generated in the boiler, which may attain a temperature upto 2000°K. Electricity is generated by passing steam through the turbine coupled to a generator.

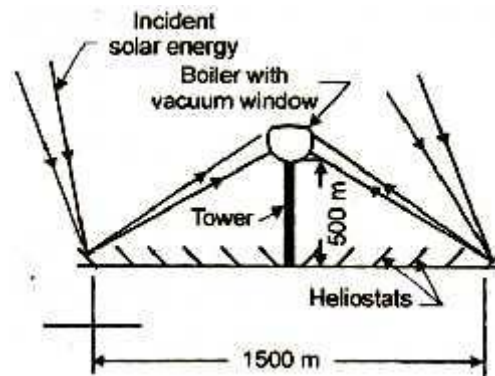

Figure: Tower concept for power generation.

5.2 advantages, disadvantages and application of Solar Energy

Advantages

1. Sun is essentially an infinite source of energy. Therefore solar energy is a very large inexhaustible and renewable source of energy and is freely available all over the world.
2. It is environmentally very clean and is hence pollution-free.
3. It is a dependable energy source without new requirements of a highly technical and specialized nature for its wide spread utilization.
4. It is the best alternative for the rapid depletion of fossil fuels.

Disadvantages

1. It is available in a dilute and is at low potential. The intensity of solar energy on a sunny day in India is about 1.1 kW/square meter area. Hence very large collecting areas are required.
2. Also the dilute and diffused nature of the solar energy needs large land area for the power plant for instance, about 30 square kilometers area is required for a solar power station to replace a nuclear plant on a 1 square kilometer site. Hence capital cost is more for the solar plant.

3. Solar energy is not available at night or during cloudy or rainy days.

Applications of Solar Energy:

Applications of solar energy enjoying most success today are:

1. Solar engines for pumping.
2. Solar water heaters.
3. Solar cookers.
4. Solar driers.
5. Solar furnaces.
6. Photo-voltaic conversion (solar cells)
7. Solar power generation.

5.3 OCEAN THERMAL ENERGY CONVERSION (OTEC)

(1) Open cycle (or) Claude cycle.

(2) Closed cycle (or) Anderson cycle.

The ocean and seas constitute about 70% of the earth's surface area and hence they represent a large storage reservoir of the solar energy. In tropical waters, the surface water temperature is about 27°C and at 1 km directly below, the temperature is about 4°C. The reservoir of surface water may be considered a heat source and the reservoir of cold water (1 km below) is considered a heat sink. The concept of ocean thermal energy conversion is based on the utilization of temperature difference between the heat source and the sink in a heat engine to generate power.

The temperature gradient present in the ocean is utilized in a heat engine to generate power. This is called OTEC. Since the temperature gradient is very small, even in the tropical region, OTEC systems have very low efficiencies and very high capital costs. There are two basic designs for OTEC systems.

1. Open cycle or Claude cycle.
2. Closed cycle or Anderson cycle.

Open cycle or Claude cycle

In this cycle, the seawater plays a multiple role of a heat source, working fluid, coolant and heat sink. Warm surface water enters an evaporator where the water is flash evaporated to steam under partial vacuum. Low pressure is maintained in the evaporator by a vacuum pump. The low pressure so maintained removes the non-condensable gases from the evaporator. The steam and water mixture from evaporator then enters a turbine, driving it thus generating electricity. The exhaust from the turbine is mixed with cold water from deep ocean in a direct contact condenser and is discharged to the ocean. The cycle is then repeated. Since the condensate is discharged to the ocean, the cycle is called 'open'.

Flash evaporation

In the evaporator the pressure is maintained at a value (0.0317 bar) slightly lower than the

saturation pressure of warm surface water at 27°C (0.0356 bar). Hence, when the surface water enters the evaporator, it gets 'superheated'. This super heated water undergoes "volume boiling" causing the water to partially flash to steam.

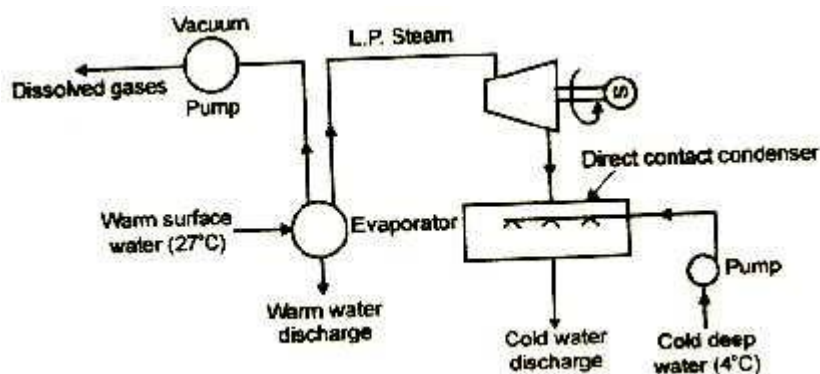

Figure: OTEC – open cycle.

Closed OTEC cycle

Here, a separate working fluid such as ammonia, propane or Freon is used in addition to water. The warm surface water is pumped to a boiler by a pump. This warm water gives up its heat to the secondary working fluid thereby losing its energy and is discharged back to the surface of the ocean. The vapours of the secondary working fluid generated in the boiler, drive a turbine generating power. The exhaust from the turbine is cooled in a surface condenser by using cold deep seawater, and is then circulated back to the boiler by a pump.

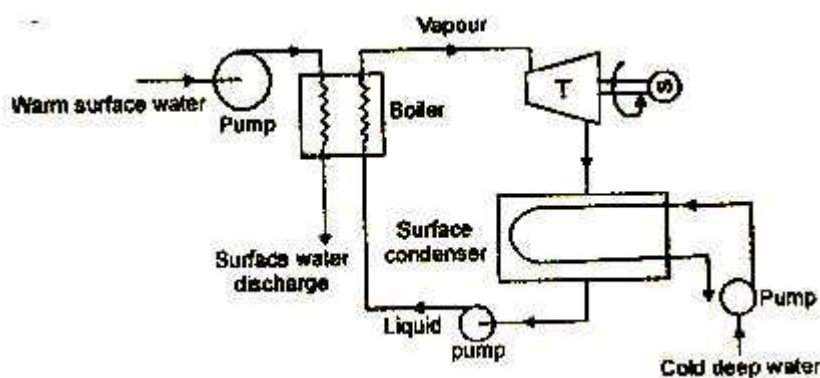

Figure: OTEC – closed cycle

Advantages of OTEC

1. Ocean is an infinite heat reservoir which receives solar incidence throughout the year.
2. Energy is freely available.

Disadvantage of OTEC

1. Efficiency is very low, about 2.5%, as compared to 30-40% efficiency for conventional

power plants.

2. Capital cost is very high.

5.4 working principle of Tidal power plants

Tide or wave is periodic rise and fall of water level of the sea. Tides occur due to the attraction of sea water by the moon. Tides contain large amount of potential energy which is used for power generation. When the water is above the mean sea level, it is called flood tide. When the water level is below the mean level it is called ebb tide.

Working

The arrangement of this system is shown in figure. The ocean tides rise and fall and water can be stored during the rise period and it can be discharged during fall. A dam is constructed separating the tidal basin from the sea and a difference in water level is obtained between the basin and sea.

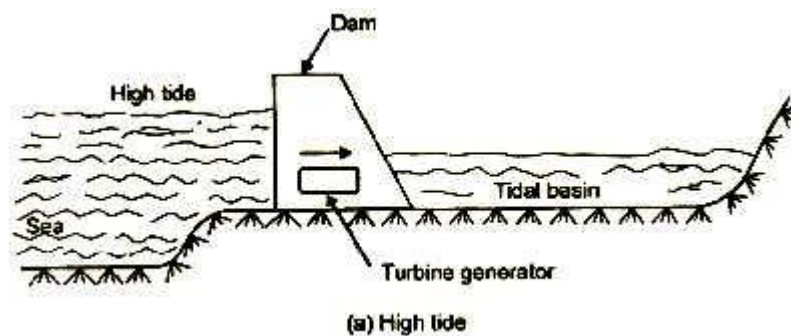

Figure: High tide

During high tide period, water flows from the sea into the tidal basin through the water turbine. The height of tide is above that of tidal basin. Hence the turbine unit operates and generates power, as it is directly coupled to a generator.

During low tide period, water flows from tidal basin to sea, as the water level in the basin is more than that of the tide in the sea. During this period also, the flowing water rotates the turbine and generator power.

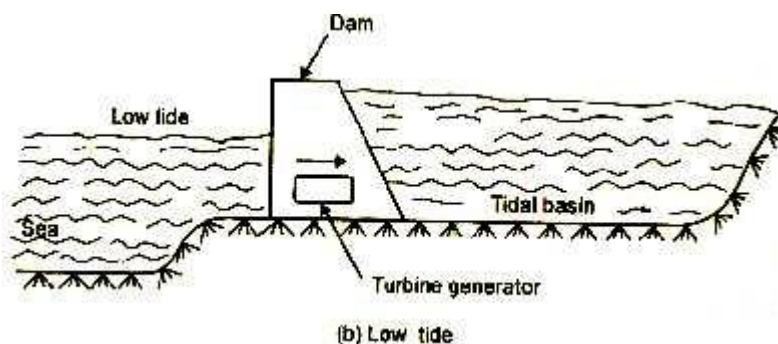

Figure : Low tide

The generation of power stops only when the sea level and the tidal basin level are equal. For the generation of power economically using this source of energy requires some minimum tide height and suitable site. Kislaya power plant of 250 MW capacity in Russia and Rance power plant in France are the only examples of this type of power plant.

Advantages of tidal power plants.

1. It is free from pollution as it does not use any fuel.
2. It is superior to hydro-power plant as it is totally independent of rain.
3. It improves the possibility of fish farming in the tidal basins and it can provide recreation to visitors and holiday makers.

Disadvantages

1. Tidal power plants can be developed only if natural sites are available on the bay.
2. As the sites are available on the bays which are always far away from load centres, the power generated has to be transmitted to long distances. This increases the transmission cost and transmission losses.

5.5 different tidal power plants

The tidal power plants are generally classified on the basis of the number of basins used for the power generation. They are further subdivided as one-way or two-way system as per the cycle of operation for power generation.

The classification is represented with the help of a line diagram as given below.

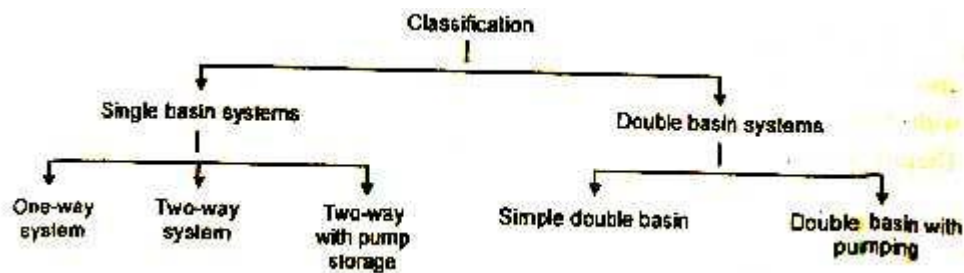

Working of different tidal power plants

1. Single basin-one-way cycle

This is the simplest form of tidal power plant. In this system a basin is allowed to get filled during flood tide and during the ebb tide, the water flows from the basin to the sea passing through the turbine and generates power. The power is available for a short duration ebb tide.

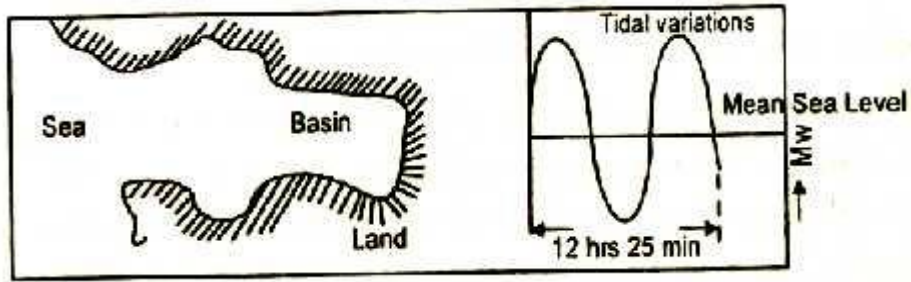

Figure: (a) Tidal region before construction of the power plant and tidal variation

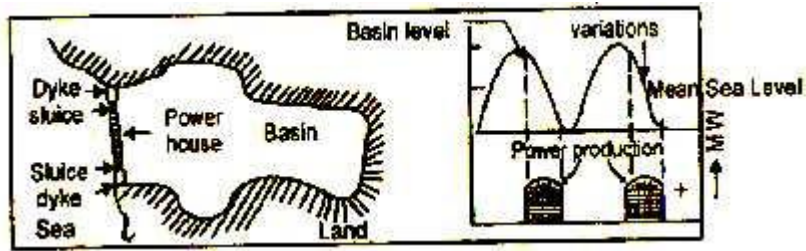

Figure: (b) Single basin, one-way tidal power plant

Figure (a) shows a single tide basin before the construction, of dam and figure (b) shows the diagrammatic representation of a dam at the mouth of the basin and power generating during the falling tide.

2. Single-basin two-way cycle

In this arrangement, power is generated both during flood tide as well as ebb tide also. The power generation is also intermittent but generation period is increased compared with one-way cycle. However, the peak obtained is less than the one-way cycle. The arrangement of the basin and the power cycle is shown in figure.

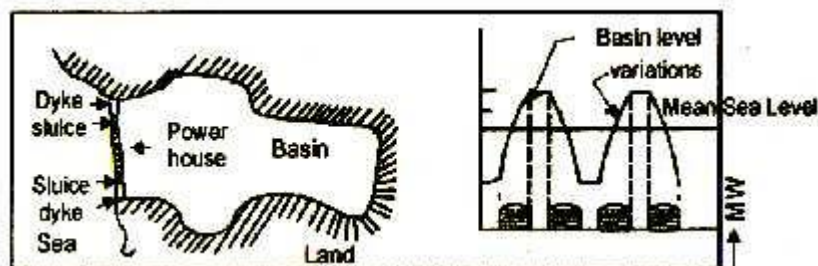

Figure: Single-basin two-way tidal power plant

The main difficulty with this arrangement, the same turbine must be used as prime mover as ebb and tide flows pass through the turbine in opposite directions. Variable pitch turbine and dual rotation generator are used of such scheme.

3. Single-basin two-way cycle with pump storage

In this system, power is generated both during flood and ebb tides. Complex machines capable of generating power and pumping the water in either directions are used. A part of the energy produced is used for introducing the difference in the water levels between the basin and sea at any time of the tide and this is done by pumping water into the basin up or down. The period of power production with this system is much longer than the other two described earlier. The cycle of operation is shown in figure.

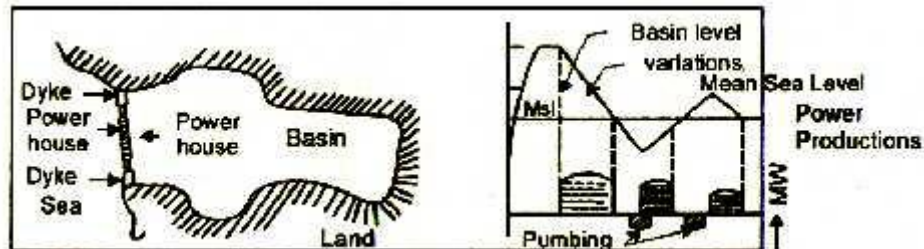

Figure: Single-basin, two-way tidal plant coupled with pump storage system.

4. Double basin type

In this arrangement, the turbine is set up between the basins as shown in figure. One basin is intermittently filled tide and other is intermittently drained by the ebb tide. Therefore, a small capacity but continuous power is made available with this system as shown in figure. The main disadvantages of this system are that 50% of the potential energy is sacrificed in introducing the variation in the water levels of the two basins.

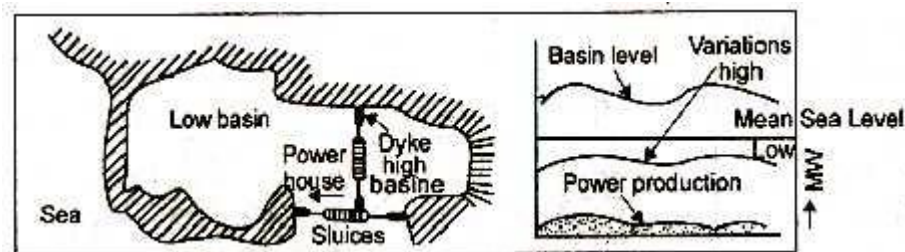

Figure: Double basin, one-way tidal plant.

5. Double basin with pumping

In this case, off peak power from the base load plant in a interconnected transmission system is used either to pump the water up the high basin. Net energy gain is possible with such a system if the pumping head is lower than the basin-to-basin turbine generating head.

5.6 kinds of Geothermal Sources Hydrothermal

systems

Hydrothermal systems are those in which water is heated by contact with the hot rock, as

explained above. Hydrothermal systems are in turn subdivided into 1) Vapor-dominated and 2) Liquid-dominated systems.

Vapor-dominated systems

In these systems the water is vaporized into steam that reaches the surface in relatively dry Condition at about 205°C and rarely above 8 bar. This steam is the most suitable for use in turboelectric power plants with the least cost. It does, however, suffer problems similar to those encountered by all geothermal systems, namely, the presence of corrosive gases and erosive material and environmental problems. Vapor-dominated systems, however, are a rarity; there are only five known sites in the world to date. These systems account for about 5 per cent of all U.S. geothermal resources. Example: Geysers plant (United States) and Larderello (Italy).

Liquid-dominated systems

In these systems the hot water circulating and trapped underground is at a temperature range of 174 to 315°C. When tapped by wells drilled in the right places and to the right depths the water flows either naturally to the surface or is pumped up to it. The drop in pressure, usually to 8 bar or less, causes it to partially flash to a two-phase mixture of low quality, i.e., liquid-dominated. It contains relatively large concentration of dissolved solids ranging between 3000 to 25,000 ppm and sometimes higher. Power production is adversely affected by these solids because they precipitate and cause scaling in pipes and heat-exchange surfaces, thus reducing flow and heat transfer. Liquid-dominated systems, however, are much more plentiful than vapor-dominated systems and next to them, require the least extension of technology.

Geopressured systems

Geopressured systems are sources of water, or brine, that has been heated in a manner similar to hydrothermal water, except that geopressured water is trapped in much deeper underground aquifers, at depths between 2400 to 9100 m. This water is thought to be at the relatively low temperature of about 160°C and is under very high pressure, from the overlying formations above, of more than 1000 bars. It has a relatively high salinity of 4 to 10 percent and is often referred to as brine. In addition, it is saturated with natural gas, mostly methane CH_4 , thought to be the result of decomposition of organic matter.

Such water is thought to have thermal and mechanical potential to generate electricity. The temperature however, is not high enough and the depth so great that there is little economic justification of drilling this water for its thermal potential alone.

Petrothermal systems

Magma lying relatively close to the earth's surface heats overlying rock as previously explained. When no underground water exists, there is simply hot, dry rock (HDR). The known temperatures of HDR vary between 150 to 290°C. This energy, called petrothermal energy,

represents by far the largest resource base of the United States. Other estimates put the ratio of steam: hot water: HDR at 1: 10: 1000.

Much of the HDR occurs at moderate depths, but it is largely impermeable. In order to extract thermal energy out of it, water (or other fluid, but water most likely) will have to be pumped into it and back out to the surface. It is necessary for the heat transport mechanism that a way be found to render the impermeable rock into a permeable structure with a large heat-transfer. A large surface is particularly necessary because of the low thermal conductivity of the rock. Rendering the rock permeable is to be done by fracturing it. Fracturing methods that have been considered involve drilling wells into the rock and then fracturing by 1) High-pressure water or 2) Nuclear explosives.

High-pressure water

Fracturing by high-pressure water is done by injecting water into HDR at very high pressure. This water widens existing fractures and creates new ones through rock displacement. This method is successfully used by the oil industry to facilitate the path of underground oil.

Nuclear explosives

Fracturing by nuclear explosives is a scheme that has been considered part of a programme for using such explosives for peaceful uses, such as natural gas and oil stimulation, creating cavities for gas storage, canal and harbor construction, and many other applications.

This method would require digging in shafts suitable for introducing and sealing nuclear explosives and the detonation of several such devices for each 200-MW plant.

The principle hazards associated with this are ground shocks, the danger of radioactivity releases to the environment, and the radioactive material that would surface with the heater water and steam.

5.7 geothermal power plant

It is also a thermal power plant, but the steam required for power generation is available naturally in some part of the earth below the earth surface. According to various theories earth has a molten core. The fact that volcanic action taken place in many places on the surface of earth supports these theories.

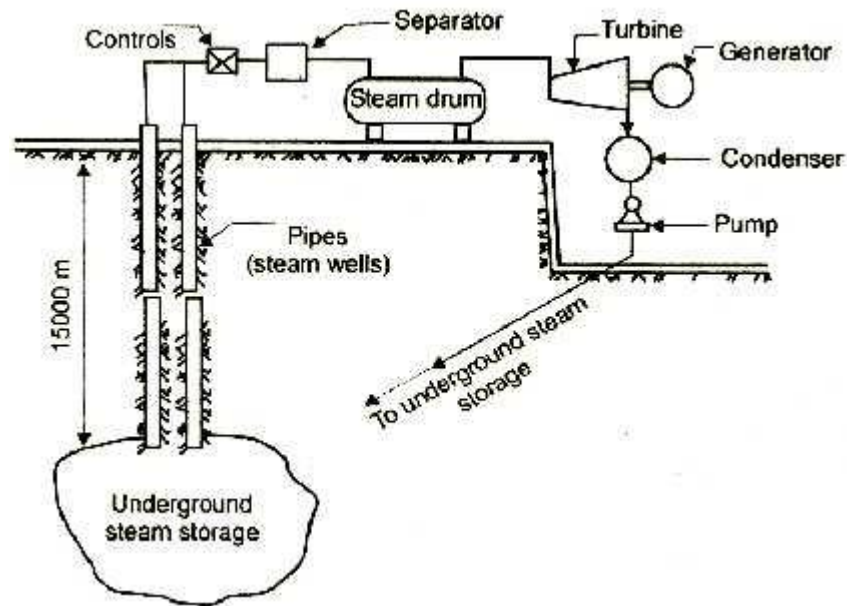

Figure: Geo-thermal power plant

Steam well

Pipes are embedded at places of fresh volcanic action called steam wells, where the molten internal mass of earth vents to the atmospheric with very high temperatures. By sending water through embedded pipes, steam is raised from the underground steam storage wells to the ground level.

Separator

The steam is then passed through the separator where most of the dirt and sand carried by the steam are removed.

Turbine

The steam from the separator is passed through steam drum and is used to run the turbine which in turn drives the generator. The exhaust steam from the turbine is condensed. The condensate is pumped into the earth to absorb the ground heat again and to get converted into steam.

Location of the plant, installation of equipment like control unit etc., within the source of heat and the cost of drilling deep wells as deep as 15,000 metres are some of the difficulties commonly encountered.

5.8 Wind-Electric Generating power plant

Figure shows the various parts of a wind-electric generating power plant. These are:

1. Wind turbine or rotor.
2. Wind mill head – it houses speed increaser, drive shaft, clutch, coupling etc.

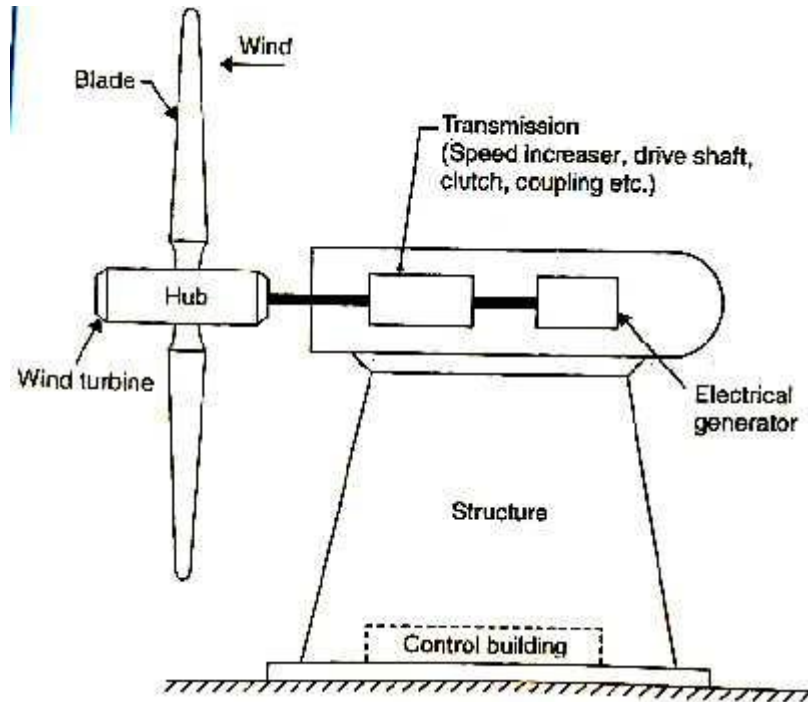

Figure: Wind-Electric generating power plant

3. Electric generator.
4. Supporting structure.

- The most important component is the **rotor**. For an effective utilization, all components should be properly designed and matched with the rest of the components.
- The wind mill head performs the following functions:

(i) It supports the rotor housing and the rotor bearings.

(ii) It also houses any control mechanism incorporated like changing the pitch of the blades for safety devices and tail vane to orient the rotor to face the wind, the latter is facilitated by mounting it on the top of the supporting structure on suitable bearings.

- The wind turbine may be located either *unwind* or *downwind* of the power. In the *unwind* location the wind encounters the turbine before reaching the tower. *Downwind rotors are generally preferred especially for the large aerogenerators.*
- The **supporting structure** is designed to withstand the wind load during gusts. Its type and height is related to cost and transmission system incorporated. Horizontal axis wind turbines are mounted on towers so as to be above the level of turbulence and other ground related effects.

Types of Wind Machines

Wind machines (aerogenerators) are generally classified as follows:

1. Horizontal axis wind machines.
2. Vertical axis wind machines.

Horizontal axis wind machines. Figure shows a schematic arrangement of horizontal axis machine. Although the common wind turbine with horizontal axis is simple in principle yet the design of a complete system, especially a large one that would produce electric power economically, is complex. It is of paramount importance's that the components like rotor, transmission, generator and tower should not only be as efficient as possible but they must also function effectively in combination.

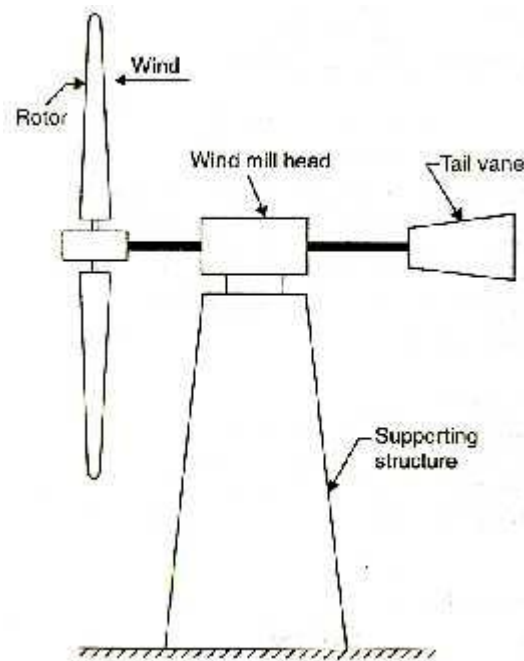

Figure: Horizontal axis wind machine.

Vertical axis wind machines. Figure shows vertical axis type wind machine. One of the main advantages of vertical axis rotors is that they do not have to be turned into the windstream as the wind direction changes. Because their operation is independent of wind direction, vertical axis machine are called panemones.

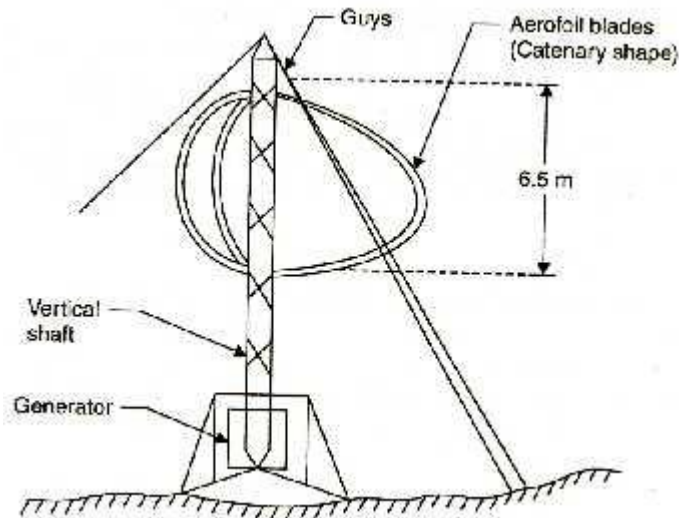

Figure: Vertical axis wind machine.

5.9 Fuel cell with Schematic diagram

A Fuel cell is an electrochemical device in which the chemical energy of a conventional fuel is converted directly and efficiently into low voltage, direct-current electrical energy. One of the chief advantages of such a device is that because the conversion, atleast in theory, can be carried out isothermally, the Carnot limitation on efficiency does not apply. A fuel cell is often described as primary battery in which the fuel and oxidizer are stores external to the battery and fed to it as needed.

Fig. shows a schematic diagram of a fuel cell. The fuel gas diffuses through the anode and is oxidized, thus releasing electrons to the external circuit; the oxidizer diffuses through the cathode and is reduced by the electrons that have come from the anode by way of the external circuit.

The fuel cell is a device that keeps the fuel molecules from mixing with the oxidizer molecules, permitting, however, the transfer of electrons by a metallic path that may contain a load.

Of the available fuels, hydrogen has so far given the most promising results, although cells consuming coal, oil or natural gas would be economically much more useful for large scale applications.

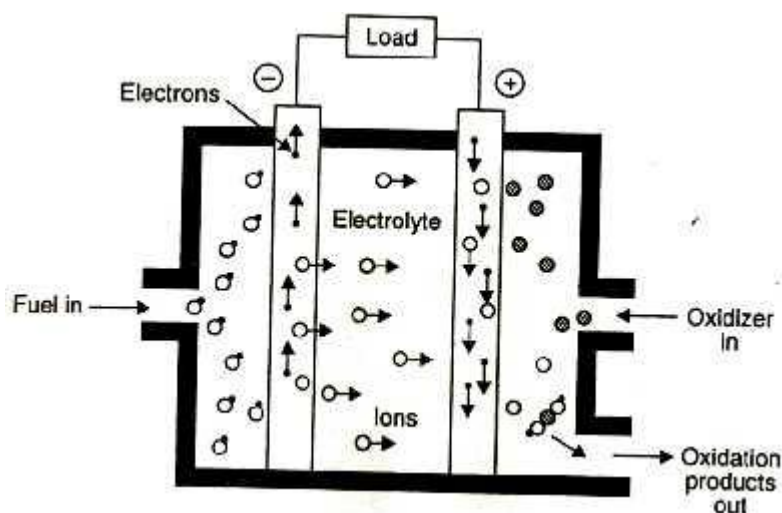

Figure: Schematic of a fuel cell.

Some of the possible reactions are :

Hydrogen/oxygen	1.23 V	$2\text{H}_2 + \text{O}_2 \rightarrow 2 \text{H}_2\text{O}$
Hydrazine	1.56 V	$\text{N}_2\text{H}_4 + \text{O}_2 \rightarrow 2\text{H}_2\text{O} + \text{N}_2$
Carbon (coal)	1.02 V	$\text{C} + \text{O}_2 \rightarrow \text{CO}_2$
Methane	1.05 V	$\text{CH}_4 + 2\text{O}_2 \rightarrow \text{CO}_2 + 2\text{H}_2\text{O}$

Hydrogen-oxygen cell :

The hydrogen-oxygen devices shown in figure is typical of fuel cells. It has three chambers separated by two porous electrodes, the anode and the cathode. The middle chamber between the electrodes is filled with a strong solution of potassium hydroxide. The surfaces of the electrodes are chemically treated to repel the electrolyte, so that there is minimum leakage of potassium hydroxide into the outer chambers. The gases diffuse through the electrodes, undergoing reactions are show below:

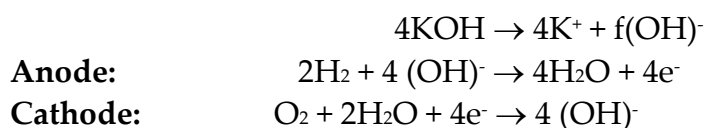

The water formed is drawn off from the side. The electrolyte provides the $(\text{OH})^-$ ions needed for the reaction, and remains unchanged at the end, since these ions are regenerated. The electrons liberated at the anode find their way to the cathode through the external circuit. This transfer is equivalent to the flow of a current from the cathode to the anode.

Such cells when properly designed and operated, have an open circuit voltage of about 1.1 volt. Unfortunately, their life is limited since the water formed continuously dilutes the electrolyte. Fuel efficiencies as high as 60%-70% may be obtained.

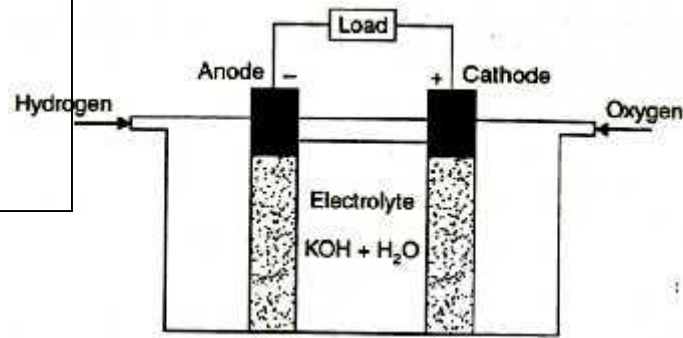

Figure: Hydrogen-oxygen fuel cell.

5.10 Magneto Hydro Dynamic (MHD) Generator and construction and working principle of MHD

Magnetohydrodynamics (MHD) is power generation technology in which the electric generator is static (nonrotating) equipment. In the MHD concept, a fluid conductor flows through a static magnetic field, resulting in a dc electric flow perpendicular to the magnetic field. MHD/steam combined cycle power plants have the potential for very low heat rates (in the range of 6,500 Btu/kWh). SO₂ and NO_x emission levels from MHD plants are projected to be very low.

MHD concept

The fundamental MHD concept is illustrated in figure. The fluid conductor is typically an ionized gas, resulting from the combustion of coal or another fossil fuel. Potassium carbonate, called seed gas, is injected during the combustion process to increase fluid conductivity. The fluid temperature is typically about 2,480 °C to 2,650 °C.

Figure: B:

The conductive fluid flows through the magnetic fields, inducing an electric field by the Faraday effect. The electric field is orthogonal to both the fluid velocity and magnetic field vectors. As a result, a potential difference is developed between the two walls of the duct as shown in figure. The direct current (dc) generated is converted to alternating current (ac) by a solid-state inverter.

Construction and Working principle

The planned application of the MHD concept for utility scale electric power generation uses MHD as a topping cycle combined with a steam bottoming cycle, as shown in figure. The topping

cycle consists of the coal combustor, nozzle, MHD channel, magnet, power conditioning equipment (inverter) and a diffuser. The bottoming cycle consists of a heat recovery/seed recovery unit, a particulate removal system, a steam turbine-generator system, cycle compressor, seed regeneration plant, and for some concepts, an oxygen plant.

The combustor burns coal to produce a uniform product gas with a high electrical conductivity (about 10 mho/m). A typical MHD plant requires combustion gases of about 2,650°C at a pressure of 5 to 10 atmospheres. The goal is to remove a large portion (50% to 70%) of the slag (molten ash) formed in the combustion process in the combustor. High ash carryover inhabits efficient seed recovery later in the process. Oxygen enriched air is used as the oxidant to achieve high flue gas temperatures.

Commercial-scale MHD plants will use superconducting magnets. Magnetic fields must be in the range of 4.5 to 6 tesla. To achieve superconducting properties, the magnets must be cooled to about 4K.

Figure: Layout of coal-fueled magnetohydrodynamics system.

In addition to converting direct current to alternating current, the power conditioning system consolidates power from the electrode pairs and controls the electric field and current. Commercial power conditioning systems will use existing line-commutated solid state inverter technology.

The diffuser is the transition between the topping cycle and the bottoming cycle. The diffuser reduces the velocity of the hot gases from the MHD channel, partially converting kinetic energy into static pressure.

The heat recovery/seed recovery unit consists of radiative and convective heat transfer surfaces to generate and super heat steam. It also removes slag and the seed from the flue gas. In addition, the heat recovery/seed recovery preheats the oxidant supply NO₂ control may be achieved within the recovery unit by a second stage of combustion. The first stage of combustion within the MHD combustor is conducted in a fuel-rich environment. The second stage of combustion within the recovery unit takes place at a temperature above 1,540°C with a residence time and cooling rate such that NO_x decomposes into N₂ and O₂.

Control of SO_x is intrinsic with the removal of the potassium seed from the flue gas. The potassium seed combines with the sulfur to form potassium sulfate, which condenses and is removed downstream by the particulate removal system. The recovered potassium sulfate is

converted to potassium seed in the seed regeneration unit.

5.11 Thermo Electric conversion system? Thermo

electric Conversion System:

The quest for a reliable, silent, energy converted with no moving parts that transforms heat to electrical power has led engineers to reconsider a set of phenomena called the Thermoelectric effects. These effects, known for over a hundred years, have permitted the development of small, self contained electrical power sources.

Seebeck (thermoelectric) effect:

The German Scientist Seebeck (in 1822) discovered that if two dissimilar material are joined to form a loop and the two junctions maintained at different temperatures, and e.m.f will be set up around the loop. The magnitude of e.m.f. will be $E = \alpha\Delta T$ where ΔT is the temperature difference between the two junctions and α is the Seebeck co-efficient. This effect has long been used in thermocouples to measure temperatures.

Thermoelectric Power Generator:

Figure shows a schematic diagram of a thermoelectric power generator. The thermocouple materials A and B are joined at the hot end, but the other ends are kept cold; an electric voltage or electromotive force is then generated between the cold ends. A.D.C (Direct Current) will flow in a circuit or load connected between these ends. The flow of current will continue as long as the heat

is supplied to the hot junction and removed from the cold ends. For a given thermocouple, the voltage and electric power output are increased by increasing the temperature difference between the hot and cold ends.

In a practical thermoelectric converter, several thermocouples are convected in series to increases both voltage and power as shown in figure. If the output voltage is insufficient to operate a particular device or equipment, it can be increased, with little loss of power, by an inverted transformers combination. The direct current generated by the thermocouples is first changed into alternating current of essentially the same average by means of an inverter. The alternating current and voltage in then increased to the desired value with the help of a transformer. The high voltage alternating current can be reconverted into direct current if required, by the use of a rectifier.

The source of heat for a thermoelectric generator may be small oil or gas burner, a radio- isotope or direct solar radiation.

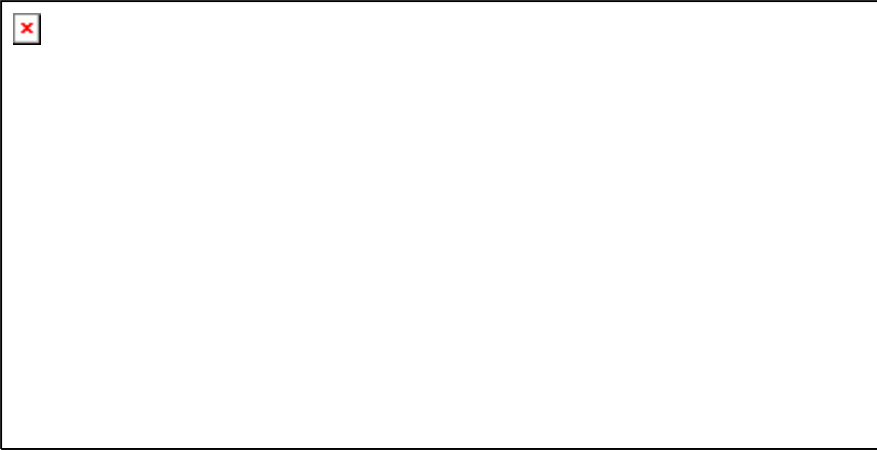

Figure: Thermoelectric generator.

Figure: Thermocouples in series (to increase voltage).

A typical couple operating with hot and cold junction temperatures of 600°C and 200°C could be designed to give about 0.1 V and 2 A i.e., about 0.5 W, so that a 1 kW device could require about 5000 couples in series.

Taking into account mechanical characteristics, stability under operating conditions and ease of fabrication, Bismuth telluride appears to be most suitable material. It can be alloyed with such materials as Bismuth selenide, Antimony telluride, Lead selenide and Tin telluride to give improved properties.

Research is being carried out on the possibility of using thermoelectric devices within the core of a nuclear reactor. The hot junction would be located on the fuel element and the cold junctions in contact with the coolants.

5.12 Thermo ionic conversion system?

Introduction:

A thermionic converter can be analyzed from at least three different points of view:

1. In terms of thermodynamics, it may be viewed as a heat-engine that uses an electron gas as a working substance.
2. In terms of electronics, it may be viewed as a diode that transforms heat to electricity by the law of thermionic emission.
3. In terms of thermoelectricity, it may be viewed as a thermocouple in which an evacuated space or a plasma has been substituted for one of the conductors.

Regardless of the point of view adopted in analysis, a thermionic converter works because of the phenomenon of 'thermionic emission'. Thermionic emission implies emission of electrons from the metal when it is heated.

Work function (ϕ):

It is defined as the energy required to extract an electron from the metal. It is measure in electron volts. The value of work function varies with the nature of the metal and its surface condition.

A thermionic converter, in principle, consists of two metals or electrodes with different work functions sealed into an evacuated vessel. The electrode with a large work function is maintained at a higher temperature that one with the smaller work function.

Thermionic generators:



Figure: Thermionic generator

A thermionic converter/generator comprises a heated cathode (electron emitter) and an anode (electron collector) separated by a vacuum, the electrical output circuit being connected between the two as shown in figure. The heat which is supplied to the cathode raises the energy of its electrons to such a level that it enables them to escape from the surface and flow to the anode. At the anode the energy of electrons appears partially as heat, removed by cooling and partially as electrical energy delivered to the circuit. Although the distance between anode and cathode is only about one millimeter, the negative space charge with such an arrangement hinders the passage of the electrons and must be reduced, this can be achieved by introducing positive ions into the interelectrode space, cesium vapour being valuable source of such ions.

In order to materialize a substantial electron emission rate (per unit area of emitter), and hence a significant current output as well as a high efficiency, the emitter temperature in a thermionic converter containing cesium should be atleast 1000°C, the efficiency is then 10 per cent.

Efficiency as high as 40 percent can be obtained by operating at still higher temperatures. Although temperature has little effect on the voltage generated, the increase in current (per unit emitter area) associated with a temperature increase results in increase in power. Electric power (P) is the product of voltage (E) and current (I) i.e., $P = EI$.

Anode materials should have a low work function e.g., barium and strontium oxides while that of the cathode should be considerable higher, tungsten impregnated with a barium compound being a suitable material. Even with these materials temperatures upto 2000°C will be required to secure for the generator itself, efficiencies of 30-35 percent. Electrical outputs of about 6 W/cm² of anode surface are envisaged with about 13 W/cm² removed by coolant.

A thermionic generator, in principle can make use of any fuel (may be fossil fuel, a nuclear fuel or solar energy) subject to the condition that sufficiently high temperatures are obtainable. The thermionic conversion can be utilized in several different situations – remote locations on the earth and in space.

Thermionic converter materials. The problem of developing materials suitable for use in thermionic converters ranks next to the space charge control problem in the development of efficient thermionic generators. Following properties are desirable in materials suitable for converters:

Emitter. A good emitter will:

- (i) have high-electron emission capability coupled with a low rate of deterioration.
- (ii) have low emissivity, to reduce heat transfer by radiation from the emitter.
- (iii) be such that in the event some of it vaporizes and the subsequently condenses on the collective).

The relative importance of these properties is dependent upon the type of converter being designed. It should be noted that efficiency is a much slower rising function of electron emission capability if space charge is present than if there is no space charge.

The work function may be reduced considerable by an absorbed single layer of foreign atoms. This comes about by the establishment of a dipole layer at the surface. The layer can be formed by atoms or molecules. This is essentially what happens in a cesium converter, which is designed so that cesium condenses on the emitter or collector.

Collector:

The main criteria for choosing a collector material is that it should have as low a work function as possible. Because the collector temperature is held below any temperature that will cause significant electron emission, its actual emission characteristics are of no consequence. The lower of the collector work function(ϕ_c), however the less energy the electron will have to give up as it enters the collector surface. In practice the lowest value of ϕ_c than can be maintained stably is about 1.5 eV. For applications in which it is desirable to maintain the collector elevated

temperatures (greater than 900°K) such as space applications, an optimum value of ϕ_c may be determined. Molybdenum has been widely used as a collector; it is frequently assumed to have a work function of 1.7 eV.

Question Paper Code : E3087

B.E. / B.Tech Degree Examination, April / May 2010

Fourth Semester

Electrical and Electronics Engineering

POWER PLANT ENGINEERING

(Regulation 2008)

Time: Three hours

Maximum: 100 Marks

Answer ALL Questions

PART A – (10 × 2 = 20 Marks)

1. Mention the various modern ash handling systems.
2. What are the factors affecting cooling of water in cooling tower?
3. Enumerate advantages and disadvantages of hydropower plants.
4. What is a surge tank?
5. What are the requirements of fission process?
6. What are the essential components of a nuclear reactor?
7. State the merits and demerits of closed cycle gas turbine over open cycle gas turbine power plant.
8. State the applications of diesel power plant.
9. What is a fuel cell?
10. What are the advantages and limitations of tidal power plant?

PART – B (5 × 16 = 80 Marks)

11. (a) Give the layout of a modern steam power plant and explain it briefly.

(or)

(b) How are cooling towers classified? Explain any one of them with a neat sketch.

12. (a) Explain with a neat sketch a pumped storage power plant.

(or)

(b) What is the function of a hydraulic turbine? How are the turbines classified? Explain any one with a suitable sketch.

13. (a) With the help of a sketch show all the important part of nuclear reactor. Describe briefly the functions of each part.

(or)

(b) Explain the following terms:

(i) Fission of nuclear fuel

(ii) Distribution of fission energy

(iii) The chain reaction

14. (a) Discuss briefly the methods employed for improvement of thermal efficiency of open gas turbine power plant.

(or)

(b) List the essential components of a diesel power plant and explain them briefly.

15. (a) Explain with a neat diagram of wind electric generating power plant.

(or)

(b) Describe open cycle MHD system with suitable sketch.
